



AUTOPILOT
SALT CHLORINE GENERATORS

Pool Pilot[®]

Digital Nano/Nano⁺

Digital Nano Models: 75040, 75040-xx, 75041 and 75041-xx
Manifolds: 75082 or 94105
Cell: RC35/22

Digital Nano⁺ Models: 75042, 75042-xx, 75043 and 75043-xx
Manifold: 94106
Cells: RC35/22 or RC28



Owner's Manual

Installation / Operation

This manual covers the installation and operation of Digital Nano and Digital Nano⁺ Chlorine Generators

Important!

Read This Manual And Product Labels Before Installing Or Operating This Equipment

INSTALLER: This Document is Purchaser's Property and is to remain with the Equipment Owner

LTP0086 Rev-1B 04/30/2013

TABLE OF CONTENTS

SECTION 1 - FACTORY CONTACT INFORMATION	5
SECTION 2 - SAFETY INFORMATION	5
SECTION 3 - OWNER QUICK START & RUN	7
3.1 How Your Digital Nano/Nano ⁺ Works	7
3.2 Control Overview	8
3.2.1 Up and Down Arrows	8
3.2.2 The Boost Button	8
3.2.3 Menu and Select Button	8
3.2.4 Check System Light and Audible Alarm	8
3.3 Normal Display	9
3.4 Water Balance & Chemistry Recommendations	9
SECTION 4 - SPECIFICATION AND APPROVALS	10
4.1 Specifications	10
4.2 Manifold Pressure Drop Versus Flow	10
4.3 Agency Approvals	10
SECTION 5 - FEATURES	11
5.1 Patented Temperature Compensation	11
5.2 Water Manifolds Assemblies - Available Options	11
5.2.1 Automatic-Flow Bypass Manifold Assembly (#94105 and #94106)	12
5.2.2 Inline-Cell Manifold Assembly (#75082)	12
5.2.3 CoPilot Manifold Assembly	12
SECTION 6 - MAINTENANCE	13
6.1 Fuse Location and Ratings	13
6.2 Removing / Inspecting / Cleaning Tri-Sensor	14
6.2.1 Tri-Sensor Assembly Overview	14
6.2.2 Inspect Tri-Sensor	14
6.2.3 Cleaning Tri-Sensor	15
6.2.4 Test Tri-Sensor Flow Switch	15
6.3 Servicing the Cell	16
6.3.1 Removal	16
6.3.2 Visual Inspection	16
6.3.3 Manual Cleaning	17
6.3.4 Installing	17
6.4 Winterizing	18
6.5 Spring Start-up	18
SECTION 7 - PROGRAMMING	19
7.1 Control Panel	19
7.1.1 Button Overview	19
7.1.2 Menu Button	19
7.1.3 Display Overview	19
7.2 Menus	20
7.3 Basic Operational Programming	20
7.3.1 Adjusting the Chlorine Output %	20
7.3.2 Boost or Super Boost	21
7.3.3 Chlorine Mode	21
7.3.4 Chlorine % Adjustment Procedure	21
7.4 Test Pool Pilot (Diagnostic Menu)	22
7.5 View Setup	22

TABLE OF CONTENTS

7.6 Review of Installer, Owner, & Maintenance Menu Programming	23
7.6.1 Pool Volume	23
7.6.2 Calibrating Salt	23
7.6.3 Select Language	23
7.6.4 Calibrating Temperature	24
7.6.5 Select Units	24
7.6.6 Temperature	24
7.6.7 Set Reverse Time	24
7.6.8 Program Cell's self-cleaning cycle	24
7.6.9 Force Reverse:	24
7.6.10 Audible Alarm:	25
SECTION 8 - INSTALLATION	25
8.1 Basic System Overview	25
8.2 Before Installing	27
8.3 Parts	27
8.4 Installation Steps	27
8.5 Plumbing Requirements	28
8.5.1 Plumbing the Manifold Assembly	28
8.6 Mounting the Digital Nano/Nano ⁺	29
8.7 Electrical	30
8.7.1 Electrical Connections	30
8.7.2 AC Input Voltage	30
8.7.3 Low Voltage Wiring	30
8.7.4 Low-Voltage Cable Connections at Control Center	31
8.7.5 Grounding and Bonding	31
8.7.6 Connecting to an External Timer or Controller	31
8.8 Preparing the Pool Water	32
8.8.1 Steps to Prepare Water	32
8.8.2 Calculating Pool Volume	33
8.8.3 Adding Salt	33
8.9 Programming at Installation	34
SECTION 9 - TROUBLESHOOTING	35
SECTION 10 - REFERENCE	40
10.1 Basic Water Chemistry	40
10.1.1 Chlorine	41
10.1.2 pH	42
10.1.3 Total Alkalinity	42
10.1.4 Calcium Hardness	42
10.1.5 Cyanuric Acid	42
10.2 Using the Saturation Index	42
10.3 Salt Addition Chart	43
10.4 Declaration of Conformity	45
10.5 FCC Compliance	45

SECTION 1 - FACTORY CONTACT INFORMATION

If you should need to call AquaCal AutoPilot for questions, services, or parts, please have your model and serial numbers available. Please also have the name of your installer and date of your equipment's installation. If you have questions, please refer to our web site for the latest manual revisions, additional information, and helpful service advice.

Web	www.AutoPilot.com
Phone	(727) 823-5642 8-5 pm, Est., M-F
Fax	(727) 821-7471
Address	AquaCal AutoPilot, Inc. 2737 24 th Street North St. Petersburg, Florida 33713 USA

Power Supply Serial	
Cell Serial	
Tri-Sensor Serial	
Installer	
Install Date	

SECTION 2 - SAFETY INFORMATION

For personal safety, and to avoid damage to equipment, follow all safety instructions displayed on the equipment and within this manual. Repair and service of your Digital Nano/Nano⁺ must be performed by qualified service personnel. Should you suspect your chlorine generator is not performing properly, refer to the section in this manual entitled: "Troubleshooting," to determine if a call for service is required. Warranties will be voided if the Digital Nano/Nano⁺ has been improperly installed. Failures to properly operate, maintain, or repair the Digital Nano/Nano⁺ will void factory warranty.

Throughout this manual safety signals are placed where particular attention is required. Please note "WARNING" signals relate to personal safety, while "CAUTION" signals promote avoiding damage to equipment.

Follow all state, provincial and NEC (National Electrical Codes) and applicable CEC (Canadian Electrical Codes) unless local guidelines supersede. When installing and using your Digital Nano/Nano⁺, basic safety precautions must always be followed, including the following:



WARNING - Failure to heed the following may result in injury or death.

- **RISK OF ELECTRICAL SHOCK** - Disconnect all AC power when installing or servicing this system. Follow all state, local, and National Electrical Code(s) (provincial and Canadian Electrical Code(s) if applicable). Use copper conductors only.
- **RISK OF ELECTRICAL SHOCK** - Digital Nano/Nano⁺ contains no Owner-repairable components. Repairs must not be attempted by untrained and/or unqualified individuals. If service is deemed necessary, contact installing dealer or AquaCal AutoPilot Customer Support.
- **RISK OF ELECTRICAL SHOCK** - A bonding lug has been provided on the outside of the Digital Nano/Nano⁺. This lug permits the connection of a No. 8 AWG (8.4mm²) solid copper-bonding conductor (No. 6 AWG in Canada). Make this connection between the Digital Nano/Nano⁺ and all other electrical equipment and exposed metal within 5-feet (1.5m) of the Digital Nano/Nano⁺. All field-installed metal components (such as rails, ladders, drains, etc.) within 10-feet of the pool, spa, or hot tub, must be bonded to the

equipment grounding bus using copper conductors not smaller than No. 8 AWG (8.4mm²) (No. 6 AWG in Canada). Maintain water chemistry in accordance with manufacturer's instructions.

- RISK OF ELECTRICAL SHOCK - Digital Nano/Nano⁺ configured to 115 Vac must be installed at least 10 feet (3 m) from the pool or spa wall. Digital Nano/Nano⁺ configured to 230 Vac must be installed at least 5 feet (1.5m) from the pool or spa wall.
- RISK OF ELECTRICAL SHOCK - A disconnect device incorporated into the fixed wiring must be included in the supply circuit (such as a time clock, relay, or circuit breaker).
- RISK OF ELECTRICAL SHOCK - Connect only to a branch circuit protected by a ground-fault circuit-interrupter (GFCI). Contact a qualified electrician if you cannot verify that the circuit is protected by a GFCI.
- RISK OF ELECTRICAL SHOCK - Digital Nano/Nano⁺ must be connected only to a supply circuit that is protected by a ground-fault circuit-interrupter (GFCI). The GFCI must be tested on a routine basis. To test, push the GFCI test button. Power should be interrupted. Push the reset button. Power should be restored. If the GFCI fails to operate in this manner, it is defective.
- RISK OF ELECTRICAL SHOCK - If the ground-fault circuit-interrupter (GFCI) interrupts power to the equipment without the test button being pushed, a ground current is flowing with a possibility of an electrical shock. Do not use equipment. Disconnect the equipment and have the problem corrected by a qualified service representative before using.
- CHEMICAL HAZARD - To avoid damaging splashes, always add acid to water, never water to acid. Wear safety glasses and use other appropriate personal protection equipment.
- CHEMICAL HAZARD - Always follow the instructions on the manufacturer's label whenever handling or using chemicals.
- CHEMICAL HAZARD – Heavy pool (or spa) usage and higher temperatures may require a higher chlorine output in order to maintain proper free available chlorine residuals.
- WATER CHEMISTRY SAFETY - Improper water chemistry can present a serious health hazard. The proper residual chlorine level and water chemistry must be maintained. The addition of certain pool maintenance chemicals can reduce the effectiveness of chlorine. Maintain Pool / Spa water per standards detailed later in this manual.
- COMBUSTIBLE HAZARD – The AquaCal AutoPilot Digital Nano/Nano⁺ is equipped with an electronic flow switch that automatically turns the unit off in the event of a “low water flow” situation. Do not tamper in any way with this safety feature.
- PERSONAL SAFETY HAZARD – To reduce the risk of injury, do not permit children to operate this device.
- RISK OF CHILD DROWNING OR INJURY - Children must be closely supervised at all times around pool or spa equipment.



CAUTION - Failure to heed the following may result in equipment damage.

- The AquaCal AutoPilot Digital Nano/Nano⁺ must be installed and operated as specified. Failure to do so will void the equipment warranty.
- To permit proper air circulation, the Digital Nano/Nano⁺ must be mounted at least 1-foot (30 cm) above ground level or any other cooling obstruction.
- Special measures are required in the event of freezing conditions. Your Digital Nano/Nano⁺ may be damaged if measures are not taken in advance of freezing

conditions. Equipment damage due to freezing conditions is NOT covered under the equipment warranty.

- Do not use a pool cleaner or vacuum head with wheels, as wheels can leave track marks on newly-plastered pools. Do not allow Granular salt to pile up in one location, without brushing, as staining may occur.
- Excessively high chlorine levels can cause premature cell failure and corrosion damage to pool fixtures and equipment.
- For maximum cell life, maintain water in a balanced condition. Water maintained in a scaling condition will shorten cell life and may render the Digital Nano/Nano⁺ inoperative. Damage and/or service calls, caused by improper water balance, will NOT be covered under the equipment warranty.
- Scraping or scratching the titanium blade's edge or surface will damage the blade catalyst coating and cause premature failure of the cell... warranty will be voided. Never use any sharp or metallic objects to remove scale.
- Reduced polarity reversing cycle times will reduce cell life, and should only be used due to uncontrollable scale formation on the Cell. ALWAYS test and adjust water balance, before attempting scale control via shortening reverse period.
- The Tri-Sensor should not be pulled out at an angle, or the flow paddle or flow post may be damaged.

SAVE THESE INSTRUCTIONS

SECTION 3 - OWNER QUICK START & RUN

- 1) Balance the water chemistry according to the water chemistry parameters on page 9 and salt recommendations on page 33. The Digital Nano/Nano⁺ may be started immediately. The salt reading, however, may initially be inaccurate until the circulation pump has been run for 24 hours to fully dissolve newly added salt.
- 2) Use the "Up" and "Down" arrow buttons to set the chlorine percentage to 50%.
- 3) During the first two weeks, test the water chemistry parameters every 3-4 days. Adjust chlorine percentage as needed.
- 4) Once ideal chlorine percentage has been determined, follow normal maintenance procedures.

3.1 HOW YOUR DIGITAL NANO/NANO⁺ WORKS

The Digital Nano/Nano⁺ is designed to handle the purification needs of residential swimming pools and spas. The amount of chlorine required for proper sanitization will vary based on the pool size and various factors such as water temperature, bather load, exposure to direct sunlight, and special water features.

The system requires a low concentration of dissolved salt (sodium chloride) in the water. The salt concentration level is normally maintained below the taste threshold. The Digital Nano/Nano⁺ automatically converts the salt into chlorine, which your pool/spa requires to remain sanitized and algae free. The chlorine reverts back to salt after treating the water. Since the salt is constantly recycled, there is minimal loss during a swimming season. However, salt can be lost due to filter backwashing, rain water overflow, leaks, or bather splashing/carry out... but not through evaporation.

The water circulation pump must be operating for your Digital Nano/Nano⁺ to produce chlorine, so run time is one of several key components to maintaining the proper sanitizer levels. Most installations require a minimum of eight (8) hours-per-day pump run time to properly filter and sanitize the water.

3.2 CONTROL OVERVIEW

The following is a brief explanation of owner or operator control options. For full features of the Owner Options Menu, please see page 23. The MENU button is pressed to obtain access to the Owner Options Menu.

Please Note: This section assumes the installer has already programmed the system for specific site parameters, has established proper water balance, and has pretreated water to 1 - 3 ppm (mg/L) chlorine.

Attention Owner: Should Centigrade vs. Fahrenheit, choice of language, or other owner options require modification, please refer to the programming information located on page 23.

See: Menu Button and Owner Options.

3.2.1 Up and Down Arrows

Use the UP and DOWN arrows to control the chlorine output level, then press the SELECT button to save the value chosen. With a properly prepared pool, the recommended starting output level is 50%.

Upon initial start-up, check sanitizer every 3-4 days and make small output level adjustments as necessary to maintain 1-3 ppm (mg/L) free chlorine levels. Keep in mind, your Digital Nano/Nano+ does not directly measure or regulate the sanitizer levels in your pool. Rather, the owner / operator will need to periodically test the water to determine the current chlorine level, and adjust the output setting as needed.

After the chlorine output level is “tuned in,” the unit will automatically make fine output adjustments as the water temperature fluctuates. This temperature compensation feature will adjust output depending on water temperature. See page 11 for more information concerning the patented temperature compensation feature.

Please Note: The optimum output setting will vary based upon pool size, location, exposure to sunlight, number of users, vegetation around the pool, water balance practices, and pump run time. Your installer should have already taken these factors into consideration when performing installation programming. Therefore, your adjustments, at this point, should be relatively minor.

3.2.2 The Boost Button

The BOOST button increases output to 100%. Use this feature when a heavier than normal bather load is anticipated.

Press BOOST once = 24 Hour Boost

Press and hold BOOST for 8 seconds = 72 Hour Boost

Press BOOST a second time = Deactivate Boost

3.2.3 Menu and Select Button

- This allows access to the “Test,” “Setup,” “Owner Option,” “Maintenance,” and “Installer” menus.
- The “SELECT” button allows the operator to choose program menu options. The owner / operator should not normally need to access these features on a regular basis.
- Consult “Programming” section, or contact factory customer support for additional information.

3.2.4 Check System Light and Audible Alarm

The CHECK SYSTEM light will flash to warn the unit may need attention. A warning message will also be displayed. If enabled, an audible alarm* may also be heard when the system light is flashing. Unless deemed a normal condition, per below, see troubleshooting section.

- Flashes red when pump is off / water flow is insufficient. (It is normal for the light to flash if the circulation pump is off)
- Flashes when salt is low

- Flashes when water temperature exceeds 125°F, or drops below 10°F

Note: When enabled, an audible alarm will sound due to any of the above three (3) conditions. If water flow ceases (or falls below minimum acceptable levels) the alarm will automatically silence after 10 minutes. To enable or disable audible alarm, see “Audible Alarm” in programming instructions.

3.3 NORMAL DISPLAY

- Chlorine Output level.....in 1% increments, from 0% to 100%
- Water Temperaturein Fahrenheit or Celsius
- Cell Status.....ON or OFF
- Check System LightOFF when operating normally
- Check System LightNormally blinking when circulation pump is off and supply power to the controller remains on.

3.4 WATER BALANCE & CHEMISTRY RECOMMENDATIONS

Proper water balance is critical to the operation of your Digital Nano/Nano⁺. Conditions such as high pH levels, low Cyanuric acid (stabilizer) levels, or other factors causing unbalanced water, will mask the sanitizer production of your Digital Nano/Nano⁺.

Please note the following recommended water chemistry parameters are for residential pool/spa applications only. Follow local regulatory guidelines for any commercial pool applications.

PARAMETER	UNITS	POOL			SPA		
		MIN	IDEAL	MAX	MIN	IDEAL	MAX
Free Chlorine	ppm (mg/L)	1.0	2.0 - 4.0	5	2.0	3.0 - 4.0	10
Combined Chlorine	ppm (mg/L)	0.0	0.0	0.2	0.0	0.0	0.5
pH		7.2	7.2 -7.8	7.8	7.2	7.2 -7.8	7.8
Total Alkalinity	ppm (mg/L)	60	80 - 100	180	60	80 - 100	180
Calcium Hardness	ppm (mg/L)	150	200 - 400	1000	100	150 - 250	1000
Salt	ppm (mg/L)	2000	2500 - 3500	**	2000	2500 - 3500	**
Cyanuric Acid (stabilizer)	ppm (mg/L)	0	30 - 50	***	0	30 - 50	***

Table 1

** Typically 6000 ppm (mg/L) or less is recommended; unit can operate with levels as high as 35,000+ ppm (mg/L).

*** This is dictated by state or local codes but is typically 100 ppm (mg/L).

See “Basic Water Chemistry” on page 40 and “Using the Saturation Index” on page 42 for further information concerning pool/spa water chemistry maintenance requirements. Or refer to the Troubleshooting section in the back of this manual.

SECTION 4 - SPECIFICATION AND APPROVALS

4.1 SPECIFICATIONS

SPECIFICATION	75040, 75040-XX	75041, 75041-XX	75042, 75042-XX	75043, 75043-XX
Input Power	110-120 Vac 2.0 A	220-240 Vac 1.0 A	110-120 Vac 2.0 A	220-240 Vac 1.0 A
Maximum Chlorine Output RC35/22	0.8 lb. /day (15.11 g/hr.)		0.8 lb. /day (15.1 g/hr.)	
Maximum Chlorine Output RC28	not applicable		1.06 lb. /day (20.0 g/hr.)	
Minimum Flow Rate for 941xx or 75082	15 gpm (76 L/min)			
Minimum Flow Rate for Co-Pilot Ozone	25 gpm (95 L/min)			
Maximum Flow Rate	100 gpm (379 L/min)			
Maximum Operating Pressure	85 psi			

Table 2

4.2 MANIFOLD PRESSURE DROP VERSUS FLOW

The following chart shows pressure drops versus flow for all Digital Nano/Nano+ manifolds. The optional CoPilot Ozone manifold is also listed.

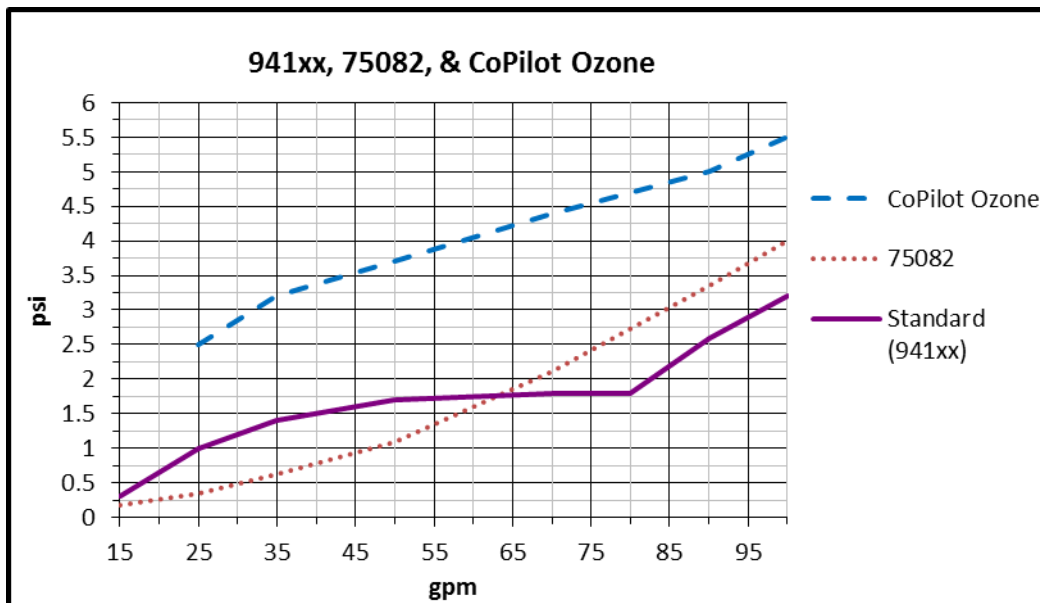

4.3 AGENCY APPROVALS

Tested to conform to the following specifications:

APPROVAL	DESCRIPTION
UL1081	Standard for Safety for Swimming Pool Pumps, Filters, and Chlorinators.
CAN / CSA-E60335-1	Safety of Household and Similar Electrical Appliances.

SECTION 5 - FEATURES

- Patented temperature compensation for chlorine output control.
- Programmable microprocessor control.
- Multi-language digital display (English, Spanish, French and either Italian or Czech).
- Digitally controlled power to the cell.
- Tri-sensor circuitry to monitor water flow, water temperature, and salt level. Calculates and provides recommended salt addition amounts required to maintain the recommended 3000 ppm (mg/L) salt concentration level.

5.1 PATENTED TEMPERATURE COMPENSATION



WARNING - Failure to heed the following may result in permanent injury or death.
Pool or Spa water temperature should not exceed 104°F (40°C).

The Tri-Sensor temperature sensor works in conjunction with the chlorine % feature to automatically adjust chlorine output based upon changes in water temperature. The automatic compensation feature operates between 55°F and 125°F (13°C - 52°C).

As water temperature falls below 65°F (18°C), the controller will activate a high chlorine percent lockout, and may not allow chlorine adjustments up to 100%. This feature prevents the controller from over-driving the cell under colder temperatures, thus preventing premature cell wear.

At 55°F (13°C) or colder water temperatures, the controller will adjust to a fixed 1% output, thus preventing over-chlorination and premature cell failure.

As the water temperature rises above set point, the controller will adjust at 5% per °F up to 100%, thus preventing under-chlorination during warmer water temperatures.

5.2 WATER MANIFOLDS ASSEMBLIES - AVAILABLE OPTIONS



CAUTION - Failure to heed the following may result in equipment damage.
The Digital Nano manifold may only use the RC35/22 cell. The Digital Nano+ may use either the RC35/22 or RC28 cell.

The Digital Nano may be operated with either the patented automatic-flow bypass manifold assembly (#94105) or the Inline-Cell Manifold Assembly (#75082). Both manifolds should ONLY use the RC35/22 cell.

The Digital Nano⁺ uses the patented automatic-flow bypass manifold assembly (#94106) with either the RC35/22 or RC28 cell.

The CoPilot manifold assembly comes with an automatic-flow bypass, check valve assembly and ozone injector venturi assembly.

5.2.1 Automatic-Flow Bypass Manifold Assembly (#94105 and #94106)

This AquaCal AutoPilot patented manifold is connected into the plumbing after all other equipment. Water from the pool/spa is moved through the manifold by the circulation pump. This patented manifold uses four key components:

- The **Tri-Sensor** provides data (from electronic sensors) to the Digital Nano/Nano+ for monitoring water flow, water temperature, and salt concentration level. The Digital Nano/Nano+ uses this data to determine if conditions are safe for the Cell to operate; the signal read from the temperature sensor allows the automatic temperature compensation feature to function.
- The **Cell** (RC35/22 or RC28) receives power from the Digital Nano/Nano+ and converts the salt contained in the water to chlorine.
- The **Strainer Screen** prevents debris in the water from entering the Tri-Sensor or Cell, and requires periodic inspection and cleaning.
- The **Bypass Check Valve** allows the water flow rate to be slowed and optimized through the Cell, while permitting the pump to continue to circulate water to-and-from the pool/spa at full flow rates. The reduced water flow through the Cell results in a more efficient "Super-Chlorination" effect, resulting in improved overall sanitization.

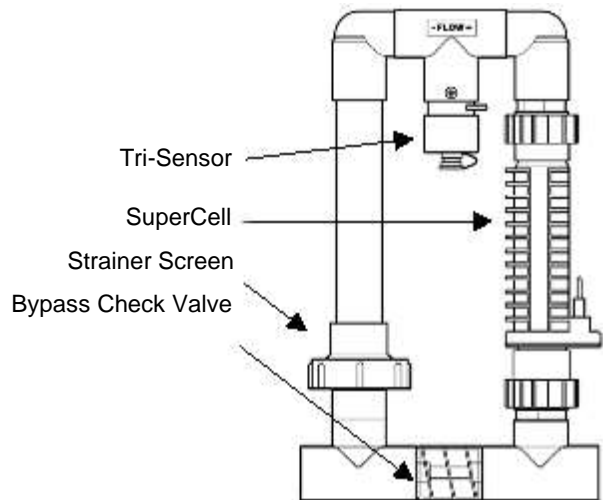

5.2.2 Inline-Cell Manifold Assembly (#75082)

The manifold is connected into the plumbing after all other equipment. Water from the pool/spa is moved through the manifold by the circulation pump. This manifold uses two key components:

- The **Tri-Sensor** provides data (from electronic sensors) to the Digital Nano for monitoring water flow, water temperature, and salt concentration level. The Digital Nano uses this data to determine if conditions are safe for the Cell to operate; the signal read from the temperature sensor allows the automatic temperature compensation feature to function.
- The **Cell** (RC35/22) receives power from the Digital Nano and converts the salt contained in the water to chlorine.

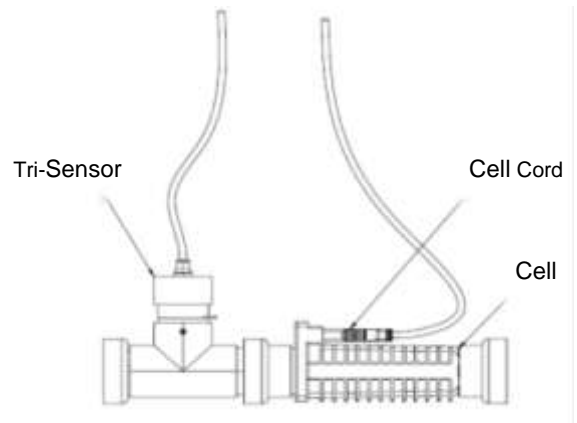

5.2.3 CoPilot Manifold Assembly

The CoPilot system is designed to be used in conjunction with the Digital Nano/Nano+ to reduce chlorine demand and extend cell life. This system is also sold separately as an upgrade to existing Digital Nano/Nano+ systems.

The manifold is connected into the plumbing after all other equipment. Water from the pool/spa is moved through the manifold by the circulation pump:

- The **Tri-Sensor** provides data (from electronic sensors) to the Digital Nano/Nano+ for monitoring water flow, water temperature, and salt concentration level. The Digital Nano/Nano+ uses this data to determine if conditions are safe for the Cell to operate; the signal

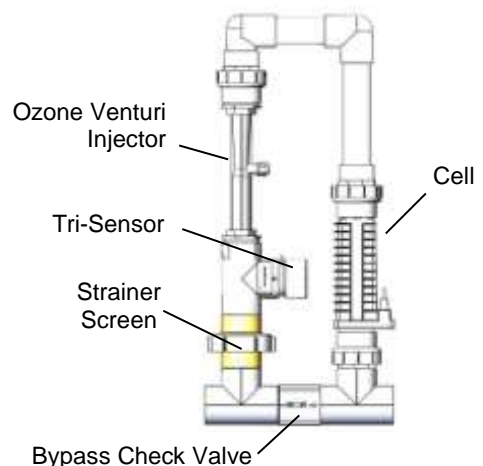

read from the temperature sensor allows the automatic temperature compensation feature to function.

- The **Cell** (RC35/22 or RC28) receives power from the Digital Nano/Nano⁺ and converts the salt contained in the water to chlorine.
- The **Strainer Screen** prevents debris in the water from entering the Tri-Sensor or Cell, and requires periodic inspection and cleaning.
- The **Bypass Check Valve** allows the water flow rate to be slowed and optimized through the Cell, while permitting the pump to continue to circulate water to-and-from the pool/spa at full flow rates. The reduced water flow through the Cell results in a more efficient "Super-Chlorination" effect, resulting in improved overall sanitization.
- The **Ozone Venturi Injector** introduces ozone directly into the water before the Digital Nano/Nano⁺ cell. The ozone venturi injector is connected to the CoPilot via an Ozone Check Valve and Tube Assembly (not shown).

SECTION 6 - MAINTENANCE

6.1 FUSE LOCATION AND RATINGS

⚠ WARNING - Failure to heed the following may result in permanent injury or death.
ELECTRICAL SHOCK HAZARD – Turn off the electrical power to unit before servicing.

To inspect or service fuse, disconnect power and remove power center cover (see below for location of fuse).

Ratings

BOARD	FUSE SPECIFICATION	DESCRIPTION
Main Power Board (Factory set as 115 Vac) 75040, 75042, 75040-xx, 75042-xx	250 Vac 2 Amp Slow Blow	Main AC Power Fuse
Main Power Board (Factory set as 230 Vac) 75041, 75043, 75041-xx, 75043-xx	250 Vac 1 Amp Slow Blow	Main AC Power Fuse

Location of Fuse

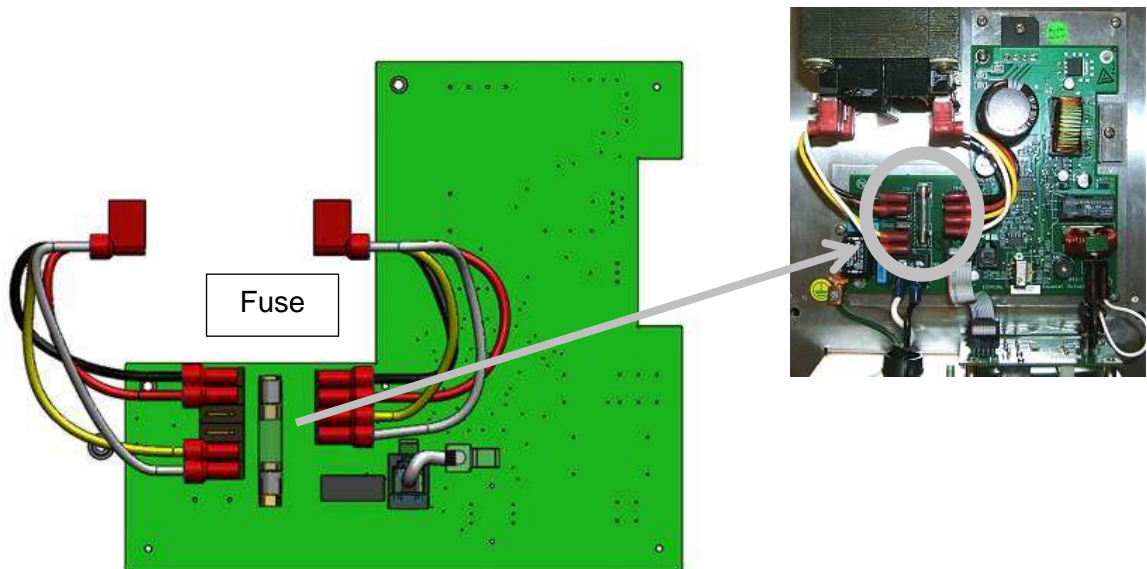

6.2 REMOVING / INSPECTING / CLEANING TRI-SENSOR

6.2.1 Tri-Sensor Assembly Overview

The Tri-Sensor Assembly is used to measure water flow, salt level, and water temperature.

Note: The use of high strength magnet devices in the close proximity of the Tri-Sensor can cause the flow switch to function incorrectly.

- When the water flow reaches a minimum flow rate of 15 gpm (76 L/min), the flow paddle magnet closes a micro-switch monitored by the Digital Nano/Nano+. The CoPilot Ozone manifold requires a minimum flow of 25 gpm (95 L/min).
- The Digital Nano/Nano+ uses dedicated salt sensor blades to measure the level of salt in the water.
- The Digital Nano/Nano+ uses the temperature

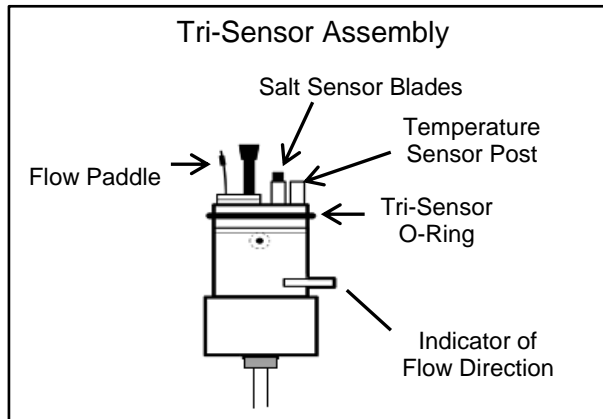

Figure 1

sensor to determine water temperature. This measurement is required for the Patented Automatic Temperature Compensation feature to automatically adjust chlorine output as water temperature varies. Less chlorine is needed in cold water, so chlorine output is automatically reduced as water temperature drops (avoiding excess chlorine production). Conversely, more chlorine is needed in warmer water, and production is automatically adjusted higher as water temperatures increase.

- Please note - the Tri-Sensor normally does not require maintenance or cleaning.



WARNING - Failure to heed the following may result in permanent injury or death.
CHEMICAL HAZARD - To avoid damaging splashes always add acid to water, never water to acid. Wear appropriate personal safety protection including safety glasses when using pool chemicals.



CAUTION - Failure to heed the following may result in equipment damage.
 The Tri-Sensor should not be removed from manifold at an angle, or the flow paddle and/or flow post may be damaged.

6.2.2 Inspect Tri-Sensor

- 1) Disconnect the Tri-Sensor cable from the power center.
- 2) Remove the two (2) screws retaining the Tri-Sensor in the Tee joint of the Manifold.
 - Note the orientation of the Directional of Flow Tab. The Tri-Sensor must be installed in the same orientation when it is reinstalled or replaced.
- 3) The Tri-Sensor can now be pulled out of the Tee.
 - Firmly grip the Tri-Sensor assembly (this is typically done with a large pair of channel lock pliers).
 - Twist the Tri-Sensor back-and-forth while simultaneously pulling the Tri-Sensor straight out of the Tee joint.
- 4) Check the tri-sensor assembly for any damage to the plastic housing and replace if needed.
- 5) Inspect the following on the flow switch: verify the thin metallic paddle is straight and free from erosion; verify the plastic post is straight and free of cracks. Do not twist or bend the paddle or the plastic post.

- 6) Inspect the two salt sensor blades. The blades should not have any mineral deposits (scale) or other debris on them.
- 7) Do not use any metallic objects to scrape the blade surfaces or you will remove or damage the blade sensor coating.

6.2.3 Cleaning Tri-Sensor

If required, you can remove a calcium scale buildup by creating a solution of water and muriatic acid as follows. Do not use any metallic objects to scrape the blade surfaces or you will remove or damage the blade sensor coating.

- 1) Mix the solution in a small container tall enough to cover the sensor blades. **DO NOT** add water to acids; always add acid to water in container.
- 2) Mix one (1) part Muriatic Acid into four (4) parts water.
- 3) Immerse the salt sensor blades in the solution for up to 15 minutes. An effervescing action indicates the calcium is being dissolved from the blades.
- 4) Rinse with fresh water and re-inspect. Repeat the acid treatment as necessary until all scale has been eliminated.

6.2.4 Test Tri-Sensor Flow Switch



WARNING - Failure to heed the following may result in permanent injury or death. Do NOT operate system with a faulty water flow switch.

The flow switch is a critical equipment protection device to prevent damage to the cell or system. When water flow has stopped, power to the Cell is automatically turned OFF. It is important to verify the proper operation of the Tri-Sensor's water Flow Switch protection device.

The following procedure can be used to verify the proper operation of the flow switch, or to flush debris from the Bypass Valve.

- 1) Turn off circulation pump.
- 2) Slightly loosen the union nut just below the cell on the side of the manifold that does not contain the filter screen.
- 3) Completely loosen the manifold union nut that contains the filter screen and pivot the manifold to gain access to the filter screen.
- 4) Remove the screen. Clean the screen if dirty.
- 5) If the screen was dirty, then the system may need to be purged to remove excess debris. Leave the manifold off and run the pump for a few seconds until clear.
- 6) Wrap the strainer screen securely with a small piece of plastic wrap (saran wrap, food wrap or zip lock bag) as indicated in the diagram, place it back in the union.
- 7) Tighten the two unions that were loosened.
- 8) Turn on the pump and the Digital Nano/Nano⁺. The plastic will stop water flow to the flow switch, which is part of the Tri-Sensor that is located in the upper portion of the manifold. All water will be forced through the Bypass Valve. This action will normally flush out any small bits of debris trapped in the Bypass Valve.)

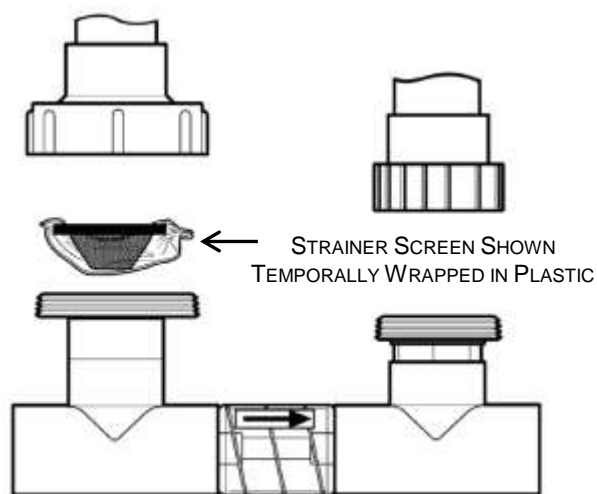

Figure 2

- 9) The Digital Nano/Nano+ should detect a low water flow at the Tri-Sensor, and activate the red “Check System” light. The Digital Nano/Nano+ will also display the message “Chlorine off Check flow.”
- 10) If the Digital Nano/Nano+ did not display this warning, check the Tri-Sensor cable connections and inspect and clean the Tri-Sensor as outlined on page 15. If the warning message still does not appear, then turn the Pool Pilot off and contact the factory or your local dealer for assistance.
- 11) Turn the pump off.
- 12) Loosen the unions.
- 13) Remove the plastic wrap and replace the strainer screen.
- 14) Resume normal operation.

6.3 SERVICING THE CELL

The Cell may require removal for periodic visual inspections, or for servicing when debris or calcium mineral deposits develop. The need to inspect and service the cell is indicated by the “Check System” light flashing and/or a screen message, “Low flow; “Error purifier off” or “Check/clean cell.”

6.3.1 Removal

The Cell is installed with Unions on each end to allow quick and easy installation and removal.

- 1) Turn off pump and shut off all power.
- 2) Detach the Cell cable from the Cell.
- 3) Unscrew the unions at both ends of the Cell.
- 4) Slide the Cell out of the Manifold Assembly.

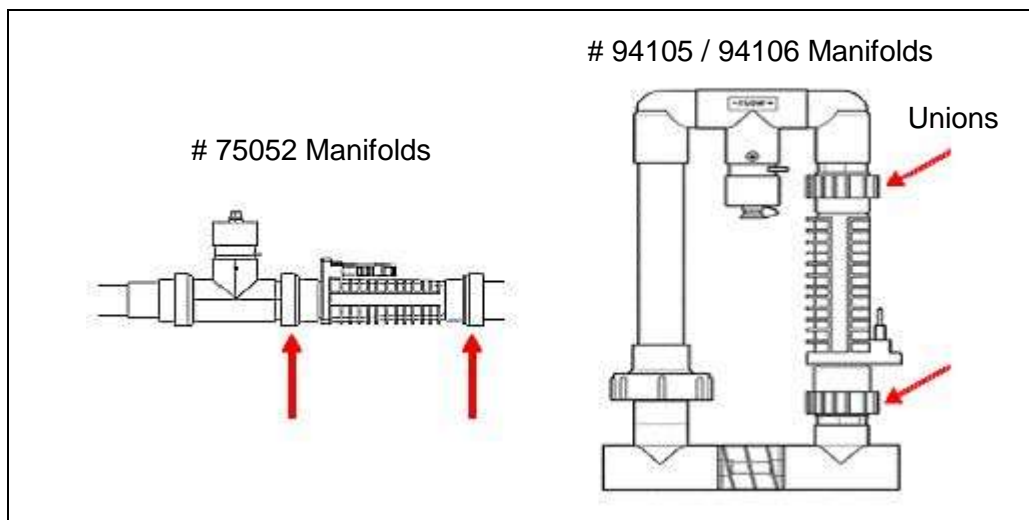
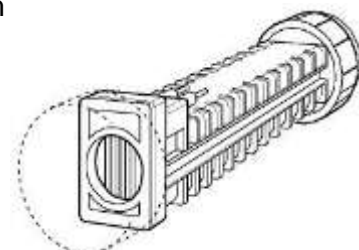

Figure 3

6.3.2 Visual Inspection

Your Digital Nano/Nano+ is designed to automatically self-clean calcium scale build up that may form on the blades during normal operation. However, unbalanced water chemistry can cause a heavy scale build up exceeding self-cleaning capabilities... thus; periodic manual cleaning may be necessary. The simplest way to avoid this extra work is to maintain the water chemistry at the levels recommended.

- 1) The Cell titanium blades, seen inside the cell body, should be straight and clear of any debris on the ends or between the blades.



End View of the SuperCell looking at the blades

Figure 4

- 2) White flaky or crusty calcium build up on the edge or between the blades will shorten the life of the cell. If required, clean the cell immediately, and determine the cause of scaling. See “Basic Water Chemistry,” and “Using the Saturation Index”.

6.3.3 Manual Cleaning



WARNING - Failure to heed the following may result in permanent injury or death.
CHEMICAL HAZARD - To avoid damaging splashes always add acid to water, never water to acid. Wear safety glasses and use other appropriate personal protection equipment.



CAUTION - Failure to heed the following may result in equipment damage. Scraping or scratching the titanium blade's edge or surface will damage the blade catalyst coating and cause premature failure of the cell... warranty will be voided. Never use any sharp or metallic objects to remove scale.

- 1) Place a PLA0113 cell cleaning plug (AutoPilot accessory) on the end of the cell as shown. A 1 ½" MPT clean out plug may also be used and can be purchased in the PVC plumbing section at most pool supply or home improvement stores.
- 2) Fill the capped cell with water 2 inches from the top of the cell blades.
- 3) Fill the rest of the cell with muriatic acid. This allows for an approximate 1-to-4 solution. Always add the acid to the water. If you do it the other way around, it can cause the solution to spray back causing serious injury.
- 4) Allow the solution to sit in the cell for 20 minutes or until the acid stops bubbling.
- 5) Safely dispose of the solution; pouring it into the pool is recommended.
- 6) Remove the cap and rinse the cell with light water pressure; re-inspect the cell, and repeat acid cleaning if the cell is still scaled.

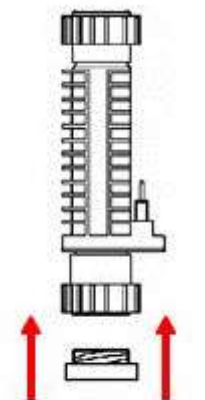

PLA0113 cell cleaning plug or 1.5" MPT Plug

Figure 5

6.3.4 Installing



CAUTION - Failure to heed the following may result in equipment damage. The Digital Nano system is to be used **ONLY** with an RC35/22 cell. Use of any other cell may cause equipment damage and void warranty.

The Digital Nano+ system can be used with the larger RC28 or the smaller RC35/22 cell (It is normally shipped with the RC28 cell).



CAUTION - Failure to heed the following may result in equipment damage. Ensure that cell cable is fully mounted. Partially seated cable may result in damage to cable or cell during operation.



CAUTION - Failure to heed the following may result in equipment damage. The electrical terminals must be completely dry to avoid corrosion and failure of the cell or cable.

- 1) Clean and dry the electrical terminals on the Cell. The contacts must be completely dry to avoid corrosion and failure of the Cell or cable.
- 2) Insure the union O-rings are in place; then place the cell into the manifold with cell pins pointed upward. See Figure 3.
- 3) Tighten the unions by hand for a watertight seal.

- 4) The Cell cable has three (3) electrical contact terminals. The Cell will have two (2) electrical terminals. Position the Cell plug so the two (2) open holes align with two mating terminals and push gently, but firmly, to connect. Use the red weather plug (supplied) to seal the unused contact in the cable.
- 5) Turn on the system.
- 6) Check for leaks and proper operation.

6.4 WINTERIZING



CAUTION - Failure to heed the following may result in equipment damage. Special measures are required in the event of freezing conditions. The Digital Nano/Nano⁺ may be damaged if measures are not taken in advance of freezing conditions. Equipment damage due to freezing conditions is NOT covered under the equipment warranty.

During brief freezing conditions, allow the filtration system to run continuously throughout the freeze period. Circulating (moving) water will not freeze.

In areas where freezing conditions are prevalent and sustained, the equipment must be winterized as follows:

- Drain all water from the Manifold Assembly (Cell and Tri-Sensor), pump, filter, supply and return lines prior to freezing weather.
- The Digital Nano/Nano⁺ power supply is not affected by the cold and does not need to be removed.

6.5 SPRING START-UP

1. It is recommended the water be manually chlorine-shocked when first starting up the pool in the springtime.
2. Test water, and add the appropriate chemicals to balance the pool water per the levels recommended in this manual.
3. Be sure to check salt and Cyanuric acid (stabilizer), bringing those readings up to the recommended levels.
4. It is also a good idea to inspect the cell, manifold screen, and test the Tri-Sensor flow switch; clean and/or replace those items as necessary.

SECTION 7 - PROGRAMMING

7.1 CONTROL PANEL

7.1.1 Button Overview

Push **UP** or **DOWN** arrow to do the following:

- Sets Chlorine Level %*
- Scrolls through Menus and Sub-Menus
- Increases or Decreases programming values for menus.

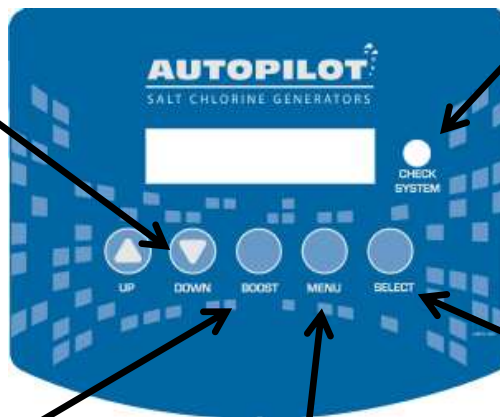

CHECK SYSTEM LIGHT:

- Red LED flashes to warn attention is required.
- A warning message will also be displayed.
- If enabled, an audible alarm may also be heard when the system light is flashing.

Push **BOOST**:

- Select to start 24 hour boost mode.
- Select and hold for eight (8) seconds to start 72 hour boost mode.
- Select again to cancel boost mode.

Push **MENU**:

Leave normal operation and access menus for programming and diagnostics

Push **"SELECT"**

Chooses item currently displayed.

7.1.2 Menu Button

The MENU button is used to leave the normal operation mode and enter the program and diagnostic modes. Use the UP/DOWN arrows and SELECT buttons to navigate through the menus and sub-menus. Note: to permit quick access to features, some functions are accessed or programmed in several menus.

- Test Pool Pilot - displays various operating parameters and diagnostic results
- View Setup - displays the programmed setup parameters
- Owner Options - programs the primary operating parameters an owner would need to change
- Maintenance Menu - tests and programs the primary features a service technician would need to access when servicing the system
- Installer Menu - program the initial system setup

Select Button

The SELECT button chooses the displayed menu option. For the Installer Menu, press and hold the SELECT button for approximately 13 seconds to access this feature. The SELECT button also temporarily disables the buzzer during an error display.

7.1.3 Display Overview

The first line of the display typically indicates Chlorine Output Level in percent, or whether the system is in Boost or Super-Boost mode. The second line displays temperature in Fahrenheit or Celsius and chlorine on/off mode. A small dot in bottom right corner indicates the self-cleaning forward/reverse cycle.

7.2 MENUS

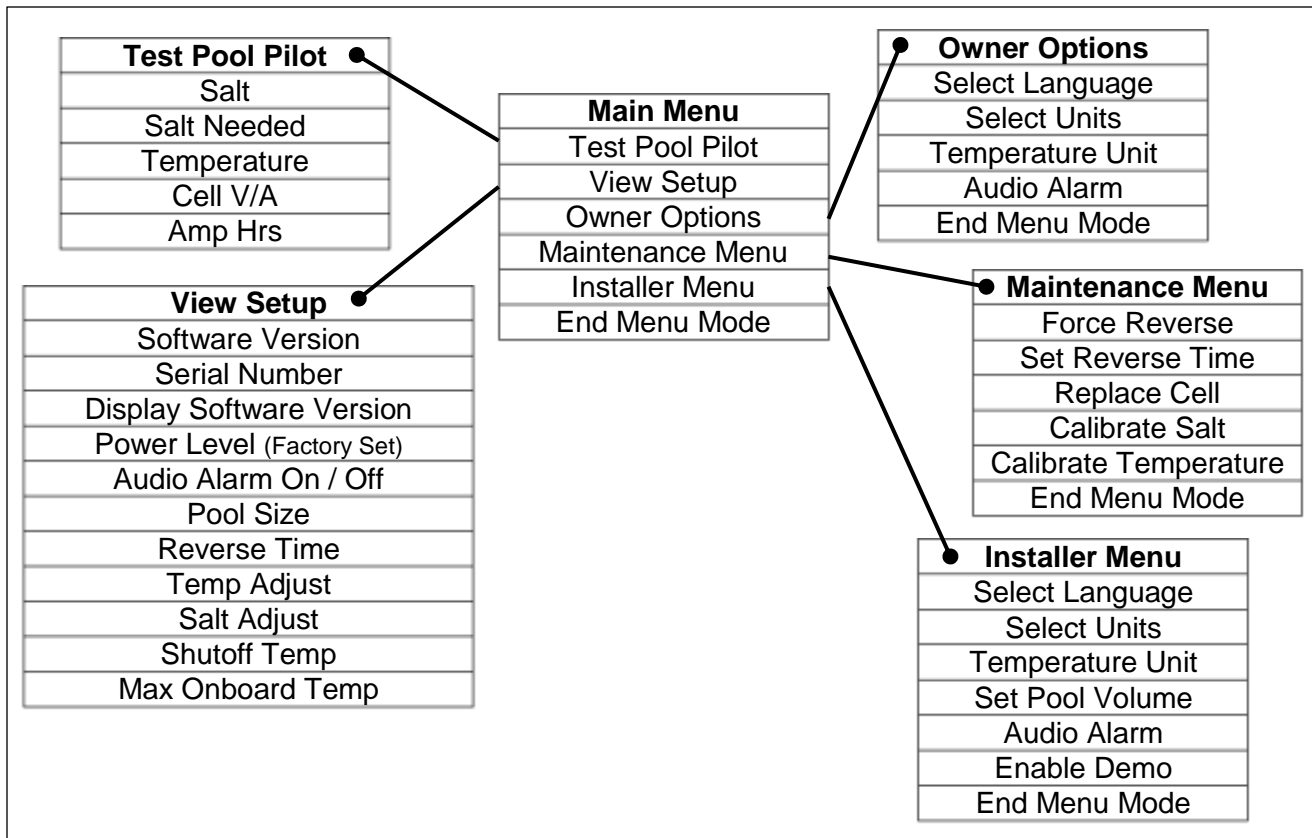

7.3 BASIC OPERATIONAL PROGRAMMING

7.3.1 Adjusting the Chlorine Output %

Typically, once the initial setting is established, very little adjustment is needed. The chlorine % setting refers to the amount of time the cell is energized within a 15 minute cycle. The system cycles on-and-off, as indicated on the display's lower right display and "ON," when generating chlorine. Higher settings will generate more chlorine.

- 1) Press the UP/DOWN (∇ or Δ) arrow buttons to enter the chlorine adjustment mode.
 - Adjust the chlorine output percentage to the desired output: from 0% (off) to 100 % (maximum output); then, press SELECT to default back to the normal display.
 - At startup of a new system, the standard output setting starting point is 50%.

Follow the instructions in the chart on page 40 to determine and correct chlorine% settings.

Example:

50% setting = 50% of 15 minutes or 7.5 minutes ON and 7.5 minutes OFF.

25% setting = 3.75 min ON, 11.25 min OFF

Once the percentage is set, the unit will implement the temperature compensation algorithm based on current water temperature.

7.3.2 Boost or Super Boost

The Boost feature is used to increase the chlorine % from its normal setting to 100% for a cumulative 24 hour or 72 hour period. When the Boost period expires or is manually terminated the chlorine % returns to its previous setting and normal operation.

- Boost chlorine output to 100% for 24 hours... From the normal operation mode, press and release the BOOST button. The display will flash: "Boost 24 hour ON," then "Boost hh" (with the "hh" actually being the displayed hours remaining in the boost period).
- Boost chlorine output to 100% for 72 hours... From normal operation mode, press and hold the BOOST button until: "Boost 72 hour ON" is displayed; then release the BOOST button. Display will show: "Boost" for approximately 8 seconds, after that: "Boost 72 hour ON" will display; then, "Boost hh" (with the "hh" actually being the displayed hours remaining in boost period).
- If an external time clock or controller turns off power to the Digital Nano/Nano⁺ while boost is active, the boost timer is stored in memory and the boost time will resume countdown when power is reapplied to the unit.
- If water flow is stopped during a Boost cycle, chlorine generation will stop while there is no flow but the Boost timer will continue to count down as long as the Digital Nano/Nano⁺ has power.

To exit Boost or Super Boost mode and revert to normal operation:

- Allow the Boost cycle to expire, or
- Press BOOST at any time to manually deactivate Boost.

7.3.3 Chlorine Mode

The Digital Nano/Nano⁺ will automatically display informative messages about the condition of the Digital Nano/Nano⁺ (Chlorine output %, water temperature, warning messages, etc.), and responds to manual adjustment of chlorine % setting (as described below). The Digital Nano/Nano⁺ will revert to the normal display if there is no activity on the keypad for thirteen (13) or more seconds.

7.3.4 Chlorine % Adjustment Procedure

- 1) Balance water chemistry according to necessary water chemistry parameters. (See basic water chemistry starting on page 40.) For new startups, if free chlorine level as tested is not at least 1 ppm (mg/L), add liquid chlorine to insure 1 to 3 ppm (mg/L) free chlorine reading.
- 2) Add the proper amount of salt as indicated by the Digital Nano/Nano⁺ (or as described on page 43), and run the circulation pump continuously for 24 hours allowing the salt to be fully mixed and dissolved into the pool. If the salt level is too low, the Digital Nano/Nano⁺ will provide a warning, and will not generate chlorine until the minimum salt level has been reached.
- 3) Use the UP and DOWN arrow buttons to set the chlorine % to 50%, and then allow the pool to operate normally.

For the first two weeks, test the water chemistry parameters every 3-4 days. Adjust chemicals as needed to maintain correct water balance.

For the Free Chlorine adjustment, use the following table for fine-tuning the controller output percentage (%):

CHLORINE % CURRENTLY SET TO:	IF FREE CHLORINE IS <u>LOWER</u> THAN IDEAL RANGE...	IF FREE CHLORINE IS <u>HIGHER</u> THAN IDEAL RANGE...
0% - 25%	The chlorine % output needs to be increased. Use the up arrow button to increase the Chlorine Output %. Press "Select" to lock in change.	The chlorine % setting is too high. Use the down arrow button to lower output. Press "Select" to lock in change. The free chlorine will need to be tested frequently and the chlorine output % will need to be adjusted as needed to attain desired level.
25% - 100%	The chlorine % output needs to be increased. Use the up arrow button to increase the chlorine output %. Press "Select" to lock in change.	The chlorine % output needs to be decreased. Use the down arrow button to decrease the chlorine output %. Press "Select" to lock in change.

After the optimal output percentage (%) has been determined, this setting will not normally require further adjustment. Select a Boost cycle to compensate for increased bather usage or heavy rainfalls (which can both quickly consume chlorine).

7.4 TEST POOL PILOT (DIAGNOSTIC MENU)

- 1) Select MENU, press UP or DOWN arrow until "Test Pool Pilot" is displayed, and press the "SELECT" button. The display will automatically toggle through the following displays. You can also select the UP or DOWN arrow to allow cycling manually forward and back.
- 2) While in this feature, selecting MENU will override the remaining displays and exit back to normal operation. The unit will automatically leave the menu and revert to normal operation after a time frame has elapsed. The following information is displayed in the view:
 - "Salt =XXXX ppm (X.x g/L)" (The optimum salt level is 3000 ppm (mg/L))
 - "Add Salt xx Lbs (xx Kg)" (The amount of salt needed to maintain 3000 ppm (mg/L))
 - "Temperature XX° F (XX° C)" (The temperature of the water flowing through the Tri-Sensor)
 - "Cell = XX V XX.x A" (The measured voltage and current sent to the Cell)
 - "Amp-Hrs = xxxxxx" (The amount of current times hours of operation received by the Cell)

7.5 VIEW SETUP

A program and parameter menu used to view the currently programmed settings.

- 1) Select MENU, press UP or DOWN arrow until "View Setup" is displayed, and press the "SELECT" button. The display will automatically toggle through the following displays. You can also select the UP or DOWN arrow to allow cycling manually forward and back.
- 2) While in this feature, selecting MENU will override the remaining displays and exit back to normal operation. The unit will automatically leave the menu and revert to normal operation after a time frame has elapsed. The following information is displayed in the view:
 - "Nano" or "Nano+"
 - "Software V X.Xx" (The version number of software)
 - "Serial #"
 - "Display V X.X.X.X (The version number of Display software)
 - "Power Level" (Set by the factory)
 - "Audio Alarm On/Off"

- “XX,XXX gallons (liters)” (The pool volume programmed in Installation Menu; 15,000 is the factory setting)
- “Reverse = X hrs.” (The reverse rate programmed in Installation Menu: 4 hrs. is factory setting)
- “Temp. adjust = X” (The temperature adjustment variation of actual tri-sensor reading; page 24)
- “Salt adjust + X %” (The salt calibration adjustment variation of actual tri-sensor reading; page 23)
- “Logging” (only appears if logging feature is enabled)
- “Shutoff Temperature” (Internal temperature of the unit at which it goes into a 5 minute cool-down period.)
- “Max Temp” (Maximum internal temperature reached)

7.6 REVIEW OF INSTALLER, OWNER, & MAINTENANCE MENU PROGRAMMING

NOTE: Once determined to be appropriately programmed for the installation site, the following menu items should not require regular access. See “Basic Operational Programming,” for setting initial Chlorine Level and routine control instructions.

7.6.1 Pool Volume

Must be programmed for the “salt amount needed” display to be accurate.

- 1) Press MENU, press ∇ or Δ until “Installer Menu” is displayed; then press and hold SELECT for 13 seconds.
- 2) Press ∇ or Δ until “Set Pool Volume” is displayed; then press SELECT.
Factory setting is 15,000 gallons. The range is 500 to 125,00 gallons (1,000 to 226,000 liters)
- 3) Press ∇ or Δ until correct pool size is displayed; then press SELECT.
- 4) Press ∇ or Δ until “End Menu Mode” is displayed; then press SELECT.

7.6.2 Calibrating Salt

Note: The unit has been calibrated at the factory and should not require further adjustments. In the event the salt display does not match on-site test results, follow these steps (it is necessary to wait 2 minutes after start-up before calibrating salt):

- 1) Press MENU, Press ∇ or Δ until “Maintenance Menu” is displayed; then press SELECT.
- 2) Press ∇ or Δ until “Calibrate Salt” is displayed; then press SELECT.
- 3) Press ∇ or Δ until the number on the display matches the accurately measured pool sample; then press SELECT. The maximum adjustment is ± 1000 ppm (mg/L).
- 4) Press ∇ or Δ until “End Menu Mode” is displayed; then press SELECT.

7.6.3 Select Language

Allow for personal preference language display.

- 1) Press MENU, press ∇ or Δ until “Owner or Installer Menu” is displayed; then press SELECT.
- 2) Press ∇ or Δ until “Select Language” is displayed; then press SELECT (English is the factory setting).
- 3) Press ∇ or Δ until desired language “English,” “Idiomia Española,” “Langue Francais,” is displayed; then press SELECT. (Digital Nano/Nano+ may also include “Lingua Italiana” or “Cesky Jazyk”.
- 4) Press ∇ or Δ until “End Menu Mode” is displayed; then press SELECT.

7.6.4 Calibrating Temperature

Note: Temperature can only be calibrated 2 minutes after start-up. Used only when it is desired to match the display of the Digital Nano/Nano+ to another on-site thermometer.

- 1) Press MENU; Press ∇ or Δ until "Maintenance Menu" is displayed; then press SELECT.
- 2) Press ∇ or Δ until "Calibrate Temp." is displayed; then press SELECT.
- 3) Press ∇ or Δ to adjust temperature up or down to the desired temperature; then press SELECT. The maximum adjustment is $\pm 6^{\circ}\text{F}$ ($\pm 3^{\circ}\text{C}$). (To maximize protection, only negative adjustments are used by equipment when calculating freeze protection temperature.)
- 4) Press ∇ or Δ until "End Menu Mode" is displayed; then press SELECT.

7.6.5 Select Units

Used to program the operator's personal preferences for the liquid and weight's measurement the Digital Nano/Nano+ will display.

- 1) Press MENU, press ∇ or Δ until "Owner" or "Installer Menu" is displayed; then press SELECT.
- 2) Press ∇ or Δ until "Select Units" is displayed; then press SELECT ("English Units" is the factory setting).
- 3) Press ∇ or Δ until desired measurement "English Units" (gallons and pounds), or "Metric Units" (liters and kilograms), is displayed; then press SELECT.
- 4) Press ∇ or Δ until "End Menu Mode" is displayed; then press SELECT.

7.6.6 Temperature

Set personal preference for temperature display (C or F)

- 1) Press MENU; press ∇ or Δ until "Owner" or "Installer Menu" is displayed; then press SELECT.
- 2) Press ∇ or Δ until "Temperature Unit" is displayed; then press SELECT ("Fahrenheit" is the factory setting).
- 3) Press ∇ or Δ until desired measurement unit "Fahrenheit" or "Celsius" is displayed; then press SELECT.
- 4) Press ∇ or Δ until "End Menu Mode" is displayed; then press SELECT.

7.6.7 Set Reverse Time



CAUTION - Failure to heed the following may result in equipment damage.

Reduced polarity reversing cycle times will *reduce* cell life and should only be used due to uncontrollable scale formation on the cell. *Always* test and adjust water balance, before attempting scale control via shortening reverse period.

7.6.8 Program Cell's self-cleaning cycle

- 1) Press MENU, press ∇ or Δ until "Maintenance Menu" is displayed; then press SELECT.
- 2) Press ∇ or Δ until "Set Reverse Time" is displayed; then press SELECT (4 hours is the factory setting).
- 3) Press ∇ or Δ until the desired cycle time (2, 4, 8, or 16 hours) is displayed; then press SELECT.
- 4) Press ∇ or Δ until "End Menu Mode" is displayed; then press SELECT.

7.6.9 Force Reverse:

Note: this is a diagnostic tool, only, and should not be used unless a problem is suspected. Program the Cell to activate a force reverse cycle and verify if the system is reversing polarity (self-

cleaning). There will be a 40 second delay, after selecting “End Menu Mode,” before reversing takes place.

- 1) Press MENU; press ∇ or Δ until “Maintenance Menu” is displayed; then press SELECT.
- 2) Press ∇ or Δ until “Force Reverse” is displayed; then press SELECT.
“Cell reversing” will display temporarily in 40 seconds.
- 3) Press ∇ or Δ until “End Menu Mode” is displayed; then press SELECT.
- 4) The “.” (period) on the end of 2nd line of the display will either appear, or disappear—based on its previous state—to indicate cell power polarity has reversed.

7.6.10 Audible Alarm:

Note: If alarm is due to low, or no water flow, audible alarm will automatically silence in 10 minutes. Upon restoration of flow, normal audible alarm operation will resume.

- 1) Press MENU; press ∇ or Δ until “Owner” or “Installer” Menu is displayed; then press SELECT.
- 2) Press ∇ or Δ until “Audio Alarm” is displayed; then press SELECT.
- 3) Press ∇ or Δ until “On -or- Off” is displayed; then press SELECT.

SECTION 8 - INSTALLATION

8.1 BASIC SYSTEM OVERVIEW

The Digital Nano/Nano+ is a salt chlorination system for pool or spa purification, and is designed to operate in the following configurations:

SHOWN WITH AUTOMATIC-FLOW BYPASS MANIFOLD ASSEMBLY (#94105 or #94106):

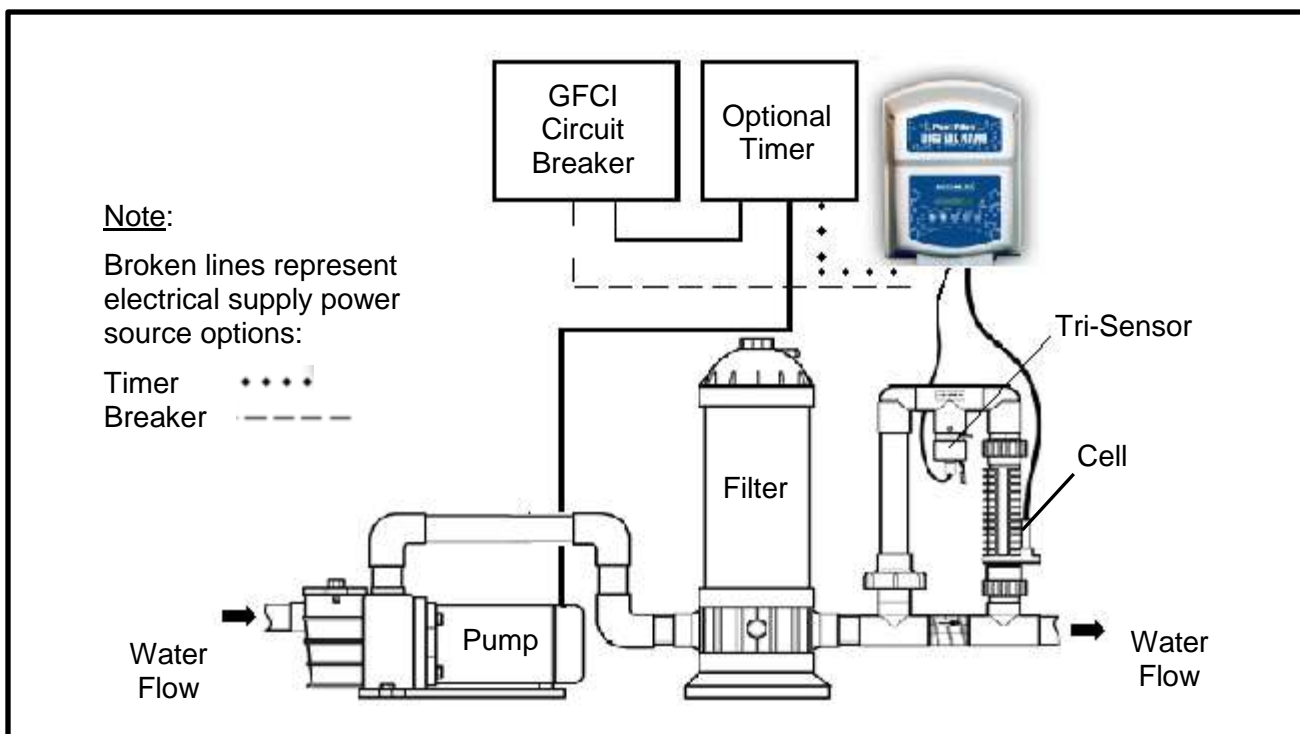

SHOWN WITH INLINE-CELL MANIFOLD ASSEMBLY (#75082)

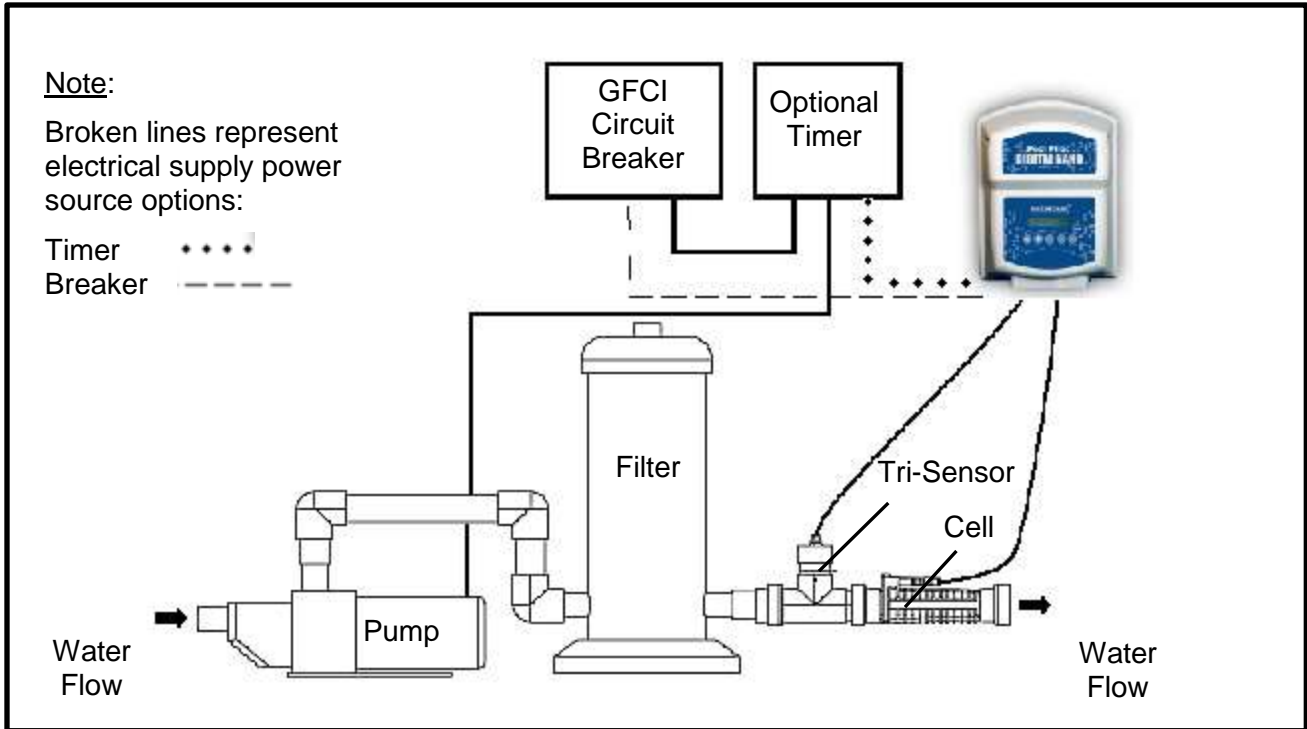

SHOWN WITH OPTIONAL COPILOT AND COPILOT MANIFOLD ASSEMBLY:

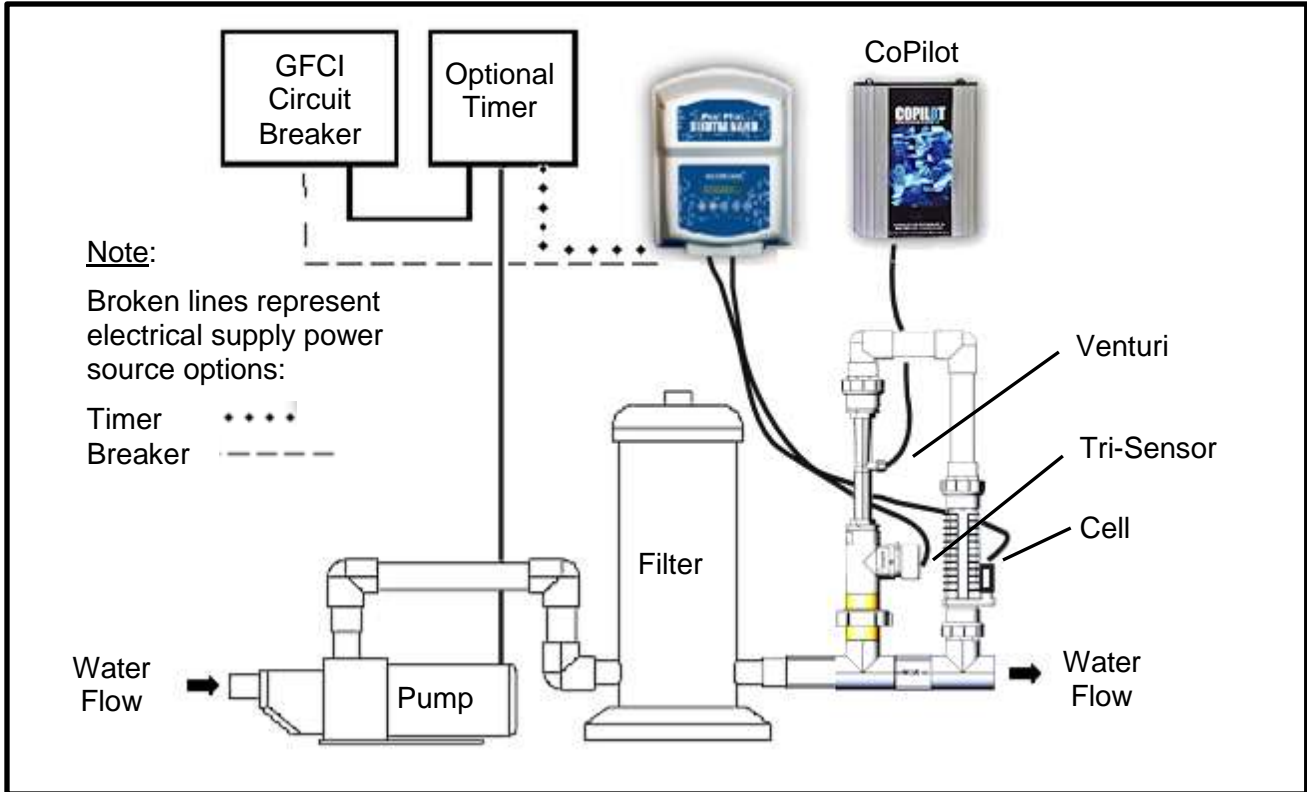

8.2 BEFORE INSTALLING

- Determine everything needed for installation is on hand.
- Determine where the Manifold Assembly will be plumbed.
- Identify a suitable mounting location for the Digital Nano/Nano⁺ within proper cord length to the manifold.
- Plan runs for Cell and Tri-Sensor Cables.
- Plan wire runs and wiring connections for source power.
- Determine origination point for control center power feed:
 - Directly from a circuit breaker (Circuit breaker is used to power the Digital Nano/Nano⁺ and circulation pump.)
 - From an external timer or an electronic controller (Digital Nano/Nano⁺ is to be wired to the same location as the circulation pump; the Digital Nano/Nano⁺ is activated when the circulation pump is energized.)
- Determine whether the input voltage for the Digital Nano/Nano⁺ will be 115 Vac or 230 Vac.

8.3 PARTS

Before attempting the installation, verify the following items have been included with the Digital Nano/Nano⁺:

Included

Digital Nano/Nano⁺ Controllers -115 Vac

QUANTITY	DESCRIPTION
1	Power Cord with 115 Volt Plug – 3 feet
1	Cell Cable
4	Plastic Anchors
4	Mounting Screws

Table 4

Digital Nano/Nano⁺ Controllers - 220 Vac

QUANTITY	DESCRIPTION
1	6 Foot AC Power Leads
1	Cell Cable
4	Plastic Anchors
4	Mounting Screws

Table 5

Not included

Power service electrical wire.
½" liquid tight (nonmetallic flex) conduit

Table 6

8.4 INSTALLATION STEPS

Details on each step of the installation process are presented on the following pages:

- 1) Plumbing the Manifold Assembly (page 28)
- 2) Mounting the Digital Nano/Nano⁺ (page 29).
- 3) Electrical Requirements & Connections (page 30).
 - a) Grounding and bonding
 - b) AC input voltage wiring (Digital Nano/Nano⁺ to an external timer or controller)

- c) Low voltage wiring
 - Cell cable
 - Tri-sensor cable
- 4) Preparing the Water (pages 32).
- 5) Programming and Setup for Site Parameters (pages 34).

8.5 PLUMBING REQUIREMENTS

The Manifold Assembly is 2" Schedule 40 PVC, and is plumbed into the pool return line; and, if applicable, after the heater and before the spa diverter valve.

8.5.1 Plumbing the Manifold Assembly

STEP-1: Select the location for installing the manifold:

- It is recommended the manifold be installed prior to installation of the Digital Nano/Nano⁺. The Digital Nano/Nano⁺ must be installed close enough to the Manifold Assembly to allow the Tri-Sensor and Cell cables sufficient slack to enable component service and maintenance. The cables are 12' long.
- If using the Bypass Manifold/Cell (# 941xx), the assembly must be installed in a vertical orientation as illustrated in the diagram on page 25. This orientation prevents hazardous gas buildup in the system, should the flow switch fail to detect insufficient flow.
- The direction of the water flow through the manifold must be as indicated for the system to operate properly.
- For a Pool/Spa combination, the manifold must be located as the last component in the pool return line (to avoid over-sanitization of the spa).

Flow Rates 15 – 100 GPM (57 – 379 L/min)

- The manifold can be directly plumbed into the system (as shown in the diagrams on the prior page).
- If the flow rate for the system is less than 15 gpm (57 L/min), a larger pump must be installed (or steps taken to improve flow rate).
- Insure flow rates for two-speed pump can provide sufficient flow at low speed.

Flow Rates Exceeding 100 gpm (379 L/min)

- A 5 lb. spring bypass check valve must be plumbed in parallel with the manifold.
- Manifolds to be installed in vertical (upright) position ONLY.

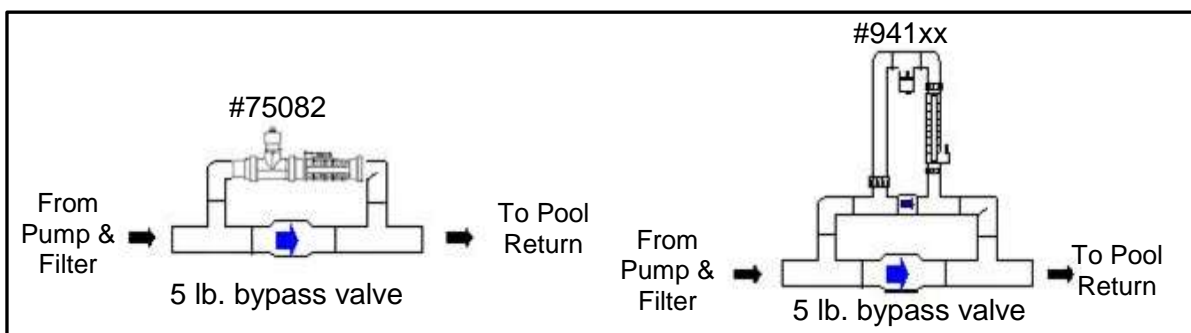

Figure 6

STEP-2: The manifolds will accept the following cells:



CAUTION - Failure to heed the following may result in equipment damage.
The Digital Nano manifold may only use the RC35/22 cell.

MANIFOLD AND CELL COMBINATIONS		
CHLORINATOR TYPE	MANIFOLD NUMBER	CELL NUMBER
The Digital Nano	941xx	RC35/22
	75082	RC35/22
The Digital Nano ⁺	94106	RC35/22
	94106	RC28

8.6 MOUNTING THE DIGITAL NANO/NANO⁺



WARNING - Failure to heed the following may result in injury or death.

- All electrical connections should be made by a licensed electrician or certified electrical contractor.
- Insure electrical power is disconnected before wiring the unit. Follow all state / local / NEC (CEC if applicable) electrical codes. Use copper conductors, only.

The Digital Nano/Nano⁺ power center is suitable for indoor or outdoor mounting. When connected to 230 Vac, the power center must be installed at least 5' (1.5 m) horizontal distance from the pool or spa wall. When connected to 115 Vac, the power center must be installed at least 10' (3 m) horizontal distance from the pool or spa wall. Greater distances may be required by local codes.

The Digital Nano/Nano⁺ power center is designed to mount vertically on a flat surface with the wiring inputs facing downward. The enclosure is designed to allow heat to dissipate from inside the box. It is important to not block the top or bottom of the enclosure.

Do NOT mount the power center inside a panel or a tightly enclosed area lacking proper and full ventilation.

When selecting a location for installing the power center, please note the Tri-Sensor and Cell cables are 12' (3.6 m) long.

ATTENTION: Verify the selected power center location is close enough to the Manifold Assembly to allow the Tri-Sensor and Cell Cables sufficient slack to accommodate later service and maintenance.

To avoid damage to wiring and connectors, thoroughly read the following section before proceeding:

1. Hold the power center chassis level in the selected mounting location. Through the top, narrow portion of mounting slots, mark the wall for the four (4) mounting holes.
2. Plastic anchors and screws have been provided for concrete or stucco walls; anchors are not required when mounting to wood or composite materials. Drill and install the plastic anchors (as applicable). Run the screws into the anchors, leaving a 1/4" gap between the wall and the underside of the screw heads.
3. Holding the power center slotted openings to the screw heads, allow the screw heads to pass through the larger portion of the mount holes; hang the power center on the four (4) mounting screws; using a long shaft screwdriver, tighten the screws.



8.7 ELECTRICAL



- CAUTION** - Failure to heed the following may result in equipment damage.
- Connecting 230Vac to a unit that has been configured to 115 Vac will result in permanent damage to the unit. Damage due to incorrect wiring is not covered under the warranty.

8.7.1 Electrical Connections

A High voltage AC input provides power to the control center. Low voltage cables provide power from the control center to the Tri-sensor and Cell.

The AC input voltage of the Digital Nano/Nano⁺ has been preconfigured at the factory.

- Model numbers 75040, 75040-xx, 75042, and 75042-xx have been configured for 115 Vac.
- Model numbers 75041, 75041-xx, 75043 and 75043-xx have been factory configured for 230 Vac.

These voltage configurations can be changed in the field by a qualified electrician if required.

- 1) Refer to the wiring diagram located on the inside of the power center cover to reconfigure the wires on the terminal block if the unit AC input voltage is going to be changed.
- 2) The fuse must be changed if the AC input is changed from the factory shipped configuration:
 - 230 Vac units require a 1 amp slow blow fuse.
 - 115 Vac units require a 2 amp slow blow fuse.

8.7.2 AC Input Voltage



- WARNING** - Failure to heed the following may result in injury or death.
- The Digital Nano/Nano⁺ supply circuit must be protected by a ground-fault circuit-interrupter (GFCI).



- CAUTION** - Failure to heed the following may result in equipment damage.
- The AC input cannot be provided by an ORP Controller.

The Digital Nano/Nano⁺ is typically provided input power either directly from a GFCI breaker or from a timer or controller. Determine which is best for your application. (Note: The 75040, 75042, 75040-xx and 75042-xx come supplied with an attached 115 Vac cable and can be connected into a time clock or 115 Vac GFCI outlet.) Although not required, ideally the pump and Digital Nano/Nano⁺ are controlled by the same timer. **SEE WARNING AND CAUTION ABOVE.**

8.7.3 Low Voltage Wiring

Connecting the Cell Cable

1. The cell cable connector is keyed and must be aligned to connect properly. Line up the cell cord and plug into the cell cord connector located on the bottom right of the Digital Nano/Nano⁺ base plate.
2. The other end of the cell cable is connected to two (2) of the cells electrical terminals. A red weather plug is placed in the unused contact hole.

Connecting the Tri-Sensor Cable

1. The Tri-Sensor Cable is 12 feet long (3.4m) and connects the Tri-Sensor Assembly to the Control Center.
2. Connect the white 6-pin connector to the mating plug located on the base of the Digital Nano/Nano⁺.
3. Position the directional tab forward in relation to water flow.

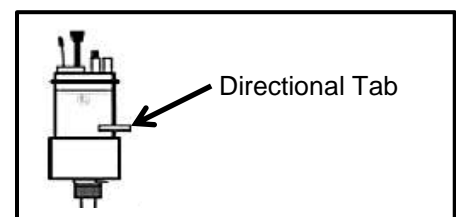

Figure 7

8.7.4 Low-Voltage Cable Connections at Control Center

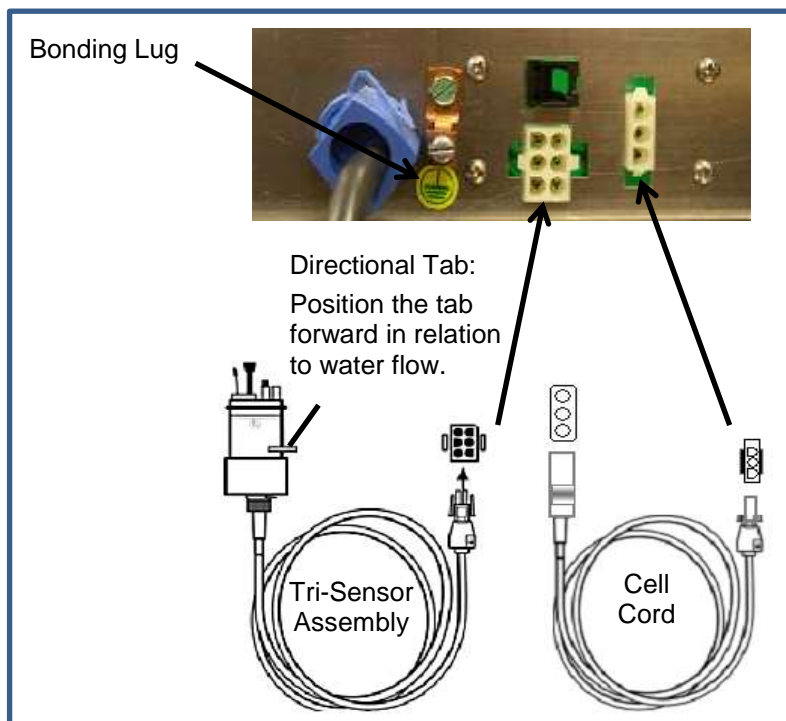

Figure 8

8.7.5 Grounding and Bonding

- Connect the green ground wire to the supply ground. See bonding lug in Figure 8.
- The Digital Nano/Nano+ must also be connected to the pool/spa bonding system with an 8 AWG (6 AWG for Canada) wire. A bonding lug is provided at the bottom, exterior of the control center.

8.7.6 Connecting to an External Timer or Controller

1. Measure and cut $\frac{1}{2}$ " nonmetallic flexible conduit to reach from the power source to the Digital Nano.
2. Feed the wires from Digital Nano through the conduit.
3. At time clock or external controller relay, connect AC power wiring to the LOAD SIDE or the same location as the circulation pump wires (pump connected to circuit breaker, time clock or electronic controller).

4. Connect the ground wire to the ground of the power source.

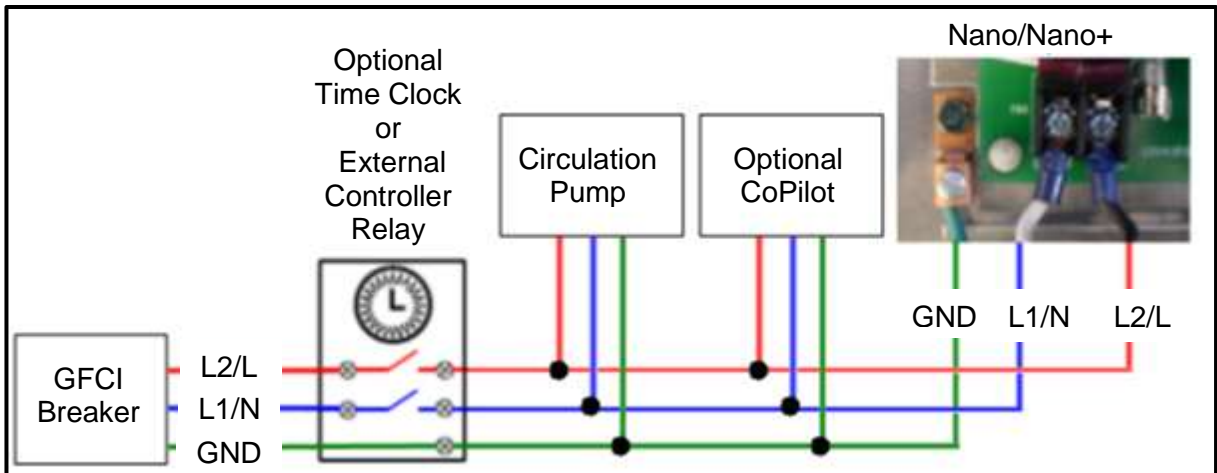

Figure 9

8.8 PREPARING THE POOL WATER

Installer please note - When properly sized to the site, the Digital Nano/Nano⁺ will meet the sanitizer “maintenance” requirements of the pool/spa. The Digital Nano/Nano⁺ is not designed to chlorine shock treat, or build up a chlorine residual, when starting with a zero or very low chlorine level.

Before starting the Digital Nano/Nano⁺, the water must be properly balanced, and the chlorine level must be adjusted to between 1 to 3 ppm (mg/L) free chlorine. More on adjusting water balance, and start-up chlorine levels, follows below.

8.8.1 Steps to Prepare Water

1. Calculate pool volume. See page 33.
2. Adjust water chemistry. Add chemicals to adjust pool or spa water chemistry parameters as indicated in the table in section 3.4 (page 9). The saturation index can be calculated using the information in section 10.2 (page 42). If the index indicates that the pool water is corrosive or scaling then adjustments to the water chemistry should be made.
3. Add initial chlorine dosage. Use sufficient chlorine as obtained from pool supply center, to achieve 1-3 ppm (mg/L) free chlorine.
4. Add salt to water (test the water for salt level first). Adjust to 3000 - 3500 ppm (mg/L). See salt chart on page 43.
5. Enter pool volume Information into control center. See “Pool Volume” programming on page 23.

8.8.2 Calculating Pool Volume

To determine the approximate number of gallons or liters in a pool or spa:

1. Determine the surface area.
2. Multiply the surface area by the average depth and the constant conversion factor of 7.5 to convert cubic feet to gallons or 1000 to convert from cubic meters to liters.

Rectangle

- Area = Length x Width
- Gallons = area x average depth (ft³) x 7.5
- Liters = area x average depth (m³) x 1000

Circular

- Area = Radius x Radius x 3.14
- Gallons = area x average depth (ft³) x 7.5
- Liters = area x average depth (m³) x 1000

To determine the approximate number of gallons or liters in a more complex shaped pool:

1. Divide the complex shape into several simple shapes.
2. Calculate each one separately, and then add back together.

Example: An oblong pool can be divided into two radius measurements and one rectangular shape. (R = Radius)

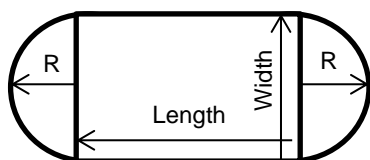

- Area = Radius x Radius x 3.14 + (Length x Width)
- Gallons = area x average depth (ft³) x 7.5
- Liters = area x average depth (m³) x 1000

8.8.3 Adding Salt

Type of Salt to Add

It is important to use Sodium Chloride (NaCl) salt that is greater than 99% pure. Acceptable types of salt include granular food grade, pool salt, water softener pellets, or solar salt flakes; these are usually available in 25 to 60lb bags (11 to 36kg) at local pool or building supply outlets. Pool salt or food grade granular salt will dissolve faster than pellets or flakes. Rock salt and Granular Salt with Iodine or Rust Preventatives should not be used, as these mixtures contain high levels of impurities and will cause staining. Granular salts containing anti-caking additives such as YPS (Yellow Prussiate of Soda) or Sodium Ferrocyanide are not recommended as they can cause a localized tint to the water or yellow staining of the pool/spa finish.

Amount of Salt Required

Test the water for current salt content first!

The ideal salt range is 3000 - 3500 ppm (mg/L). The minimum salt level is 2500 ppm (mg/L). However, if so desired, the Digital Nano/Nano⁺ can operate with salt levels in excess of 35,000 ppm (mg/L). Salt levels above 6000 ppm (mg/L) are not normally recommended, as corrosion issues may result. Salt levels below 2400 ppm (mg/L) will reduce the efficiency of the Digital Nano/Nano⁺, and will result in low chlorine production. Extremely low salt levels below 1900 ppm (mg/L) will activate the low salt safety cut off, and will halt chlorine production until salt is replenished to proper levels. Once the Digital Nano/Nano⁺ is programmed to the pool water volume, the controller will automatically indicate how much salt is required to attain ideal salt levels.

See the reference table, on page 43 for information on amount of salt to be added relative to the volume of water to be treated vs. existing salt level.

How to Add Salt to Pool



- CAUTION** - Failure to heed the following may result in equipment damage.
Do not use a pool cleaner or vacuum head with wheels, as wheels can leave track marks on newly-plastered pools. Do not allow Granular salt to pile up in one location, without brushing, as staining may occur.

The circulation pump should be run continuously until the salt has been fully dissolved – typically 24 hours. Add salt directly to pool (or spa, if a spa-only installation), and over the main drain (if main drain is present). If there is no main drain, a vacuum head may be used to encourage salt circulation. Distributing the salt through brushing is also helpful; brush the salt toward the main drain (if one is present). Set pump operation to normal run time after salt has fully dissolved into water.

If the salt level becomes undesirably high, the only way to remove excess salt is to partially drain the pool/spa and refill with fresh water.

8.9 PROGRAMMING AT INSTALLATION

The Digital Nano/Nano+ requires the pool volume be initially programmed into the installer menu. The control center will then indicate how many pounds (kgs) of salt to add should salt levels fall. The default pool size is 15,000 gallons (56781 liters). The salt chart (on page 43) can also be used to calculate how much salt in pounds (kgs) should be added to reach the recommended level of 3000 ppm (mg/L) salinity.

1. Enter the Installer Menu and program. "Set Pool Volume" for specific pool. See Calculating Pool Volume on page 33.
 - Press MENU,
 - Press ∇ or Δ until "Installer Menu" is displayed;
 - Press and hold "SELECT" for 13 seconds to enter the Installer Menu.
 - Press ∇ or Δ until "Set Pool Volume" is displayed; then press SELECT.
 - Factory setting is 15,000 gallons.
 - The range is 500 to 125,000 gallons (2,000 to 500,000 liters)
 - Press ∇ or Δ until correct pool size is displayed; then press SELECT.
 - Press ∇ or Δ until "End Menu Mode" is displayed; then press SELECT.
2. Configure the following as needed. See *Section 7.6 on page 23 for more information.*
 - "Select Language"
 - "Select Units"
 - "Temperature Units"
 - "Audio Alarm"
3. Press ∇ or Δ to adjust chlorine output to 50%.

SECTION 9 - TROUBLESHOOTING

MESSAGE DISPLAYED	PROBLEM	TYPICAL SOLUTION
Cell inspect due	This is an advisory message. The unit will generate chlorine normally while this message is displayed.	The cell has been operating for a while. This is a reminder that now would be a good time to remove and inspect the cell and filter screen to see if they need cleaning. No problem has been detected. This is simply a time elapsed maintenance message. Press "Select" to clear this message.
Cell is cleaning	This is an advisory message.	The cell is reversing polarity when this message is displayed. Normal production will resume shortly.
Error purifier off Check flow	Chlorine generation has stopped due to insufficient water flow.	<p>Turn on the circulation pump.</p> <ul style="list-style-type: none"> • Turn the control valves to the correct position to allow water flow through the manifold. • If installed, check suction type vacuum cleaner for blocked or restricted water flow. • Check and clean the skimmer basket. • Check and clean the pump basket. • Check and clean or backwash the main circulation filter. • Clean the manifold screen of trash or debris. For instructions to clean the screen, test the flow switch, clean the bypass valve (on a bypass manifold only), see Maintenance section of manual. • Verify that the Tri-Sensor cable is plugged in. Plug it in, using care to orient it correctly before inserting it. Clean the Cell if plugged with debris or calcium scale (See Maintenance section of manual.) • Check for air in the bypass manifold by loosening the top union on the cell to see if air or water comes out. If air comes out then there may be a vacuum side leak or the pump may be undersized. Check for leak at pump basket O-ring, leaking valve or fitting. • If the pump is a 2-speed pump, is it on low speed? The low speed may not create enough flow for the manifold.
Error purifier off Add Salt xxx lb	Chlorine generation has stopped because the salt level is below 1900 ppm (mg/L) (which is too low).	Add salt as indicated on the Digital Nano/Nano ⁺ display to bring the salt level up to 3000 ppm (mg/L).
Warning! Add Salt xxx lb	The salt level is between 2000-2400 ppm (mg/L) (which is too low).	Add salt as indicated on the Digital Nano/Nano ⁺ display to bring the salt level up to 3000 ppm (mg/L).
Error purifier off Add Salt xxx lb Warning! Add Salt xxx lb	Added salt as indicated by the Digital Nano/Nano ⁺ , but salt level still shows low.	<ul style="list-style-type: none"> • The pool volume has not been set up in the Installer Menu and is higher than the factory default of 15,000 gallons (56,000 liters). • The salt sensor in the Tri-Sensor may be dirty. • The Salt display may need to be calibrated.

MESSAGE DISPLAYED	PROBLEM	TYPICAL SOLUTION
No Error Displays	Salt level on display does not match pool store or salt test strip.	<ul style="list-style-type: none"> The test may have been faulty or the salt strips may be old or damaged. Have salt level rechecked at local pool store. If the discrepancy is more than 400 (mg/L), then calibrate salt. See "Calibrating Salt" on page 23 for more information.
Warning! Check/clean cell See additional troubleshooting on this error later in section.	Conductivity of the water is reduced; usually caused by low salt, cold water or a scaled cell or a combination thereof.	<ul style="list-style-type: none"> Check the salt level and adjust to 3000 ppm (mg/L) or verify salt calibration. For water temperatures below 65°F (18.3°C), increase salt to 3500 ppm (mg/L). Remove and inspect the cell for white calcium scale. (See cell inspection and cleaning instructions in the Maintenance section of manual.)
	The salt level is below 2800 ppm (mg/L) & temperature below 70°F (21°C).	Increase salt level to 3500 ppm (mg/L) or increase temperature on heater if applicable.
	The salt display differs from salt test.	Adjust salt display in the Salt Calibration mode. (See Calibrating Salt, in the Programming section of manual.)
	The cell is scaled.	Determine frequency of scaling. <ul style="list-style-type: none"> ONE week or less = Power Supply not reversing polarity – contact factory. TWO weeks or more = Water Chemistry related problem (See Reference section of manual, Water Chemistry and Saturation Index topics). Adjust water chemistry or adjust "Set Reverse" to a shorter cycle.
	If this is a new installation...	Verify the incoming voltage matches the voltage of the Digital Nano/Nano ⁺ . (See Specifications and Installation sections of manual.)
Warning! Low Amps: Cell? See additional troubleshooting on this error later in section.	Cell is completely clogged from calcium scale, has failed, or the cell cord is loose or damaged.	<ul style="list-style-type: none"> Check cell for calcium scale buildup. Clean as needed. Check for visual wear on the edges of the terminal blades which may be an indication that cell is depleted. Check the cell cord for tight connections on the cell and on the power supply. Check the plug for burns. Tighten or replace as needed. Replace cell if depleted.
	The cell cord is disconnected	Verify cell cables are inserted fully into the Digital Nano/Nano ⁺ base cell connector.
	The cell is heavily scaled.	Remove and acid wash as described in Maintenance section of manual.
	If this is a new installation...	Verify that the incoming voltage matches the voltage of the Digital Nano/Nano ⁺ . (See Specifications and Installation sections of manual.)

MESSAGE DISPLAYED	PROBLEM	TYPICAL SOLUTION
Warning! Low Amps: Cell?	Cell is not receiving the expected Amps.	Enter "Test Pool Pilot" mode through the menu. Write down the salt level, water temperature, and cell volts and amps. <ul style="list-style-type: none"> • If the volts are 24-26, then the problem is usually caused by low salt, improperly connected, disconnected or loose cell cord, water less than 65°F (18.3°C), a scaled cell, or cell near end of life. Correct as appropriate. • If the volts are less than 20, then contact Autopilot Systems for assistance. Installer: If the unit is configured for 230 Vac operation, then verify the input AC voltage is not 115 Vac. Supply correct voltages or reconfigure the unit as appropriate.
Warning! Check/clean cell		
Warning! Low Cell volts	Cell is shorted	<ul style="list-style-type: none"> • Check cell for calcium scale buildup. Clean as needed. • Check call for wire or other debris that is shorting the electrodes.
	Cell cord is defective	<ul style="list-style-type: none"> • The cell cord has a short. Replace.
Warning! Bad temp sensor?	Temperature is out of range.	<ul style="list-style-type: none"> • Check the Tri-sensor cable; make sure it is not disconnected or loose. • Check the water temperature. • If confirmed temperature is OK, contact AquaCal AutoPilot for assistance.

MESSAGE DISPLAYED	PROBLEM	TYPICAL SOLUTION
Normal display	There are no warning messages on the display but the chlorine level is too low. Water quality looks dirty or cloudy.	<ul style="list-style-type: none"> ● The chlorine setting has been fine, but a temporary boost of chlorine is needed to adjust for rain or a temporary bather increase. Press the Boost button to temporarily elevate the chlorine production level to 100% for 24 hrs. The chlorine output will revert to the original setting after 24 hrs. ● The chlorine setting has been fine, but a temporary (or longer) Super Boost of chlorine is needed to adjust for heavier rain or bather increase. Press and hold the Boost button for 8 seconds to temporarily elevate the chlorine production level to 100% for 72 hrs. The chlorine output will revert to the original setting after 72 hrs. ● Check pool chemistry parameters. (See Water Balance & Chemistry Recommendations in the Owner's Quick Start section of manual.) The Cyanuric acid level may be low and the chlorine is being consumed quickly by the UV from the sun. ● The chlorine output needs to be increased. <ul style="list-style-type: none"> ● Use the up arrow key to increase the chlorine output setting. ● Increase the pump run time so the Digital Nano/Nano⁺ is generating chlorine for a longer period of time. ● Test water for high phosphate levels. Use a product such as "Lo-Phos" to reduce phosphates if the phosphate level is higher than 22 ppm (mg/L). ● If the water temperature is 55°F (10°C) or colder, the Pool Pilot has automatically turned the Chlorine output down to 1% to avoid over-chlorination. Bacteria and algae activity is greatly reduced at these temperatures; so, this should not be a problem. Hand dose additional chlorine if necessary. ● Obtain an independent salt reading to check the Pool Pilot reading. Add salt, if needed, and recalibrate the Pool Pilot salt display. ● Check the Max Temp in the setup menu. If higher than the Shutoff temp., unit may be going into a cooling mode. Shade, or relocate unit to an area less affected by direct sunlight or other sources of heat external to the unit.

MESSAGE DISPLAYED	PROBLEM	TYPICAL SOLUTION
Normal Display (Continued)	There are no warning messages on the display. The chlorine level is too low but the pool water looks fine.	<ul style="list-style-type: none"> • The test kit reagents or strips may be old or have been exposed to sunlight. Replace the kit or reagents and retest. • There is too much chlorine in the pool. The chlorine is bleaching the test kit reagents. Dilute the water sample with distilled water and retest. Lower the chlorine output setting with the down arrow button if the chlorine level is too high. • Possible power supply fault. <ul style="list-style-type: none"> • Press "Boost". Wait 10 seconds for the unit to start the Boost cycle. • Press "Menu". Select "Test Pool Pilot" • Record the Volts and Amps when displayed. If the volts are less than 4.0 and the Amps are less than 1.5, contact the factory for assistance.
Chlorine display	Chlorine locked at 1%	If the water temperature is 55°F (10°C) or colder the Pool Pilot has automatically turned the Chlorine output down to 1% to avoid over-chlorination. Bacteria and algae growth is greatly reduced at this temperature, so this should not be a problem.
	Chlorine % fluctuates from adjusted value	The AutoPilot unit has a patented process for automatically increasing and reducing the chlorine output as the temperature of the water fluctuates. It is normal for the % output to increase as the water temperature increases, and to decrease as the water temperature decreases.
Blank display	The Pool Pilot Display is blank.	<ul style="list-style-type: none"> • If the display is in bright sunlight, then shade the display to read. • Verify external time clock has not turned off power to Digital Nano/Nano⁺. (Temporarily override the time clock, if desired, to check the Digital Nano/Nano⁺.) • Verify local shut off switch and/or main circuit breaker for Digital Nano/Nano⁺ is turned on. • If power is provided to unit by an external control device, verify power is provided to and from the device. • Fuse may be blown. See fuse replacement in maintenance section.
Cooling	Unit is not generating Chlorine	Internal temperature of unit has exceeded "Shutoff Temp", viewable on Setup Menu. Will turn off chlorine generation for five (5) minutes or until temperature decreases. <ul style="list-style-type: none"> • Wait until unit cools down. • Move Digital Nano/Nano⁺ to a shaded area if too hot.

MESSAGE DISPLAYED	PROBLEM	TYPICAL SOLUTION
(<u>All</u> three of the following messages are being displayed.) Warning! Low Amps: Cell? Warning! Low Cell volts Warning! No Output	Power supply fault	<ul style="list-style-type: none"> NOTE: If all 3 messages are not being displayed then refer to the specific individual fault message above. All 3 messages must be displayed for this to be a power supply fault. Contact factory for service

SECTION 10 - REFERENCE

10.1 BASIC WATER CHEMISTRY

The Digital Nano/Nano+ is designed to produce chlorine on a daily basis. To monitor the system's efficiency, the water chemistry ranges, and schedule of periodic checks should be followed. See "Water Balance & Chemistry Recommendations" on page 9 for chemistry levels.



CAUTION - Failure to heed the following may result in equipment damage.

- Excessively high chlorine levels can cause premature cell failure and corrosion damage to pool fixtures and equipment.
- Always follow the instructions on the manufacturer's label whenever handling or using chemicals

CHEMICAL	IDEAL TEST SCHEDULE	EFFECT OF LOW / HIGH LEVELS	CORRECTIVE ACTIONS
Free Chlorine	Weekly	<u>Low free chlorine</u> : Not enough residual chlorine to safely sanitize pool water.	<u>Low free chlorine</u> : Check for combined chlorine level and shock as necessary. Increase chlorine output to maintain a 1-3 ppm (mg/L) residual reading.
		<u>High free chlorine</u> : Corrosive to metallic fixtures in pool water. Can bleach swimwear and hair.	<u>High free chlorine</u> : Decrease chlorine output. Let chlorine dissipate normally until 1-3 ppm (mg/L) is achieved. In extreme cases, pool water can be diluted with fresh water or a chlorine neutralizer added. (Diluting will reduce salt and CYA. Check and adjust as needed.)
pH	Weekly	<u>Low pH</u> : (acidic) Equipment corrosion, eye/skin irritation, plaster etching, rapid chlorine consumption	<u>Low pH</u> : Add sodium carbonate or soda ash
		<u>High pH</u> : (basic) Scale formation, cloudy water, eye/skin irritation, poor chlorine effectiveness	<u>High pH</u> : Add muriatic acid or sodium bisulfate.
Total Alkalinity	Monthly	<u>Low TA</u> : Eye irritation, pH "bounce", stained/etched plaster and metal corrosion.	<u>Low TA</u> : Add sodium bicarbonate.
		<u>High TA</u> : Constant acid demand, difficulty in maintaining pH, and contributes to scale formation or cloudy water conditions.	<u>High TA</u> : Add muriatic acid often or sodium bisulfate, a little at a time (may take a week or more to lower the TA).

CHEMICAL	IDEAL TEST SCHEDULE	EFFECT OF LOW / HIGH LEVELS	CORRECTIVE ACTIONS
Calcium Hardness	Monthly	<u>Low CH</u> : Etching of plaster, equipment corrosion	<u>Low CH</u> : Add calcium chloride flakes.
		<u>High CH</u> : Scale formation, cloudy water. Rapid buildup of scale may exceed the system's self-cleaning capability and require manual cleaning of the Cell.	<u>High CH</u> : Partially drain and refill pool with fresh water to dilute. (Diluting will reduce salt and CYA. Check and adjust as needed.)
Cyanuric Acid (CYA or Stabilizer)	Monthly	<u>Low CYA</u> : destruction of chlorine by the UV rays from the sun.	<u>Low CYA</u> : Add Cyanuric acid (1 lb. per 5000 gallons increases CYA 25 ppm (mg/L))
		<u>High CYA</u> : Requires more chlorine to maintain proper sanitizer levels. Note: CYA not needed for indoor pools or bromine pools. CYA can be reduced to 30 - 50 ppm (mg/L) for in colder climate regions.	<u>High CYA</u> : Partially drain and refill pool with fresh water to dilute. (Diluting will reduce salt. Check and adjust as needed.)
Saturation Index	Monthly	± 0.3 : Water is scale forming. Calcium carbonate is falling out of solution. This rapid buildup of scale may exceed the system's self-cleaning capability and require manual cleaning of the Cell.	<u>Balance water</u> as close to equilibrium of 0 as possible. See page 42 for more information.
		$- 0.3$: Water is corrosive. Water will take away other material it comes in contact with to form a natural balance. These materials can be metallic fixtures, swimwear, etc. Results can also include cloudy water, eye/skin irritation, and poor chlorine effectiveness.	<u>Balance water</u> as close to equilibrium of 0 as possible. See 42 for more information.
Salt	Monthly	<u>Low Salt</u> : Below 2,400 ppm (mg/L) causes premature cell failure and reduces chlorine production	<u>Low Salt</u> : Add salt according to digital display on Pool Pilot unit or salt chart.
		<u>High Salt</u> : Above 6,000 ppm (mg/L) can cause corrosion of metallic fixtures and will taste salty. Note: Digital Nano/Nano ⁺ can safely operate with salt levels up to 35,000.	<u>High Salt</u> : If undesirably high, partially drain and refill the pool with fresh water. (Diluting will reduce CYA. Check and adjust as needed.)

Table 7

10.1.1 Chlorine

The desirable form of chlorine is called Free Chlorine. This form of chlorine is responsible for the actual sanitation activity in pools and spas. Free chlorine is highly reactive and once added to pool/spa water has a tendency to combine with organic matter in the pool/spa. It quickly attacks pathogens as well as other bather wastes. When chlorine combines it chemically changes. The chlorine binds to organic matter is referred to as the Combined Chlorine. Combined chlorine is responsible for eye burn and skin irritations. Total chlorine is the sum of free chlorine and combined chlorine. If a strong chlorine odor is noted, it is due to an excess of combined chlorine. It is important to test Total Chlorine as well as Free Chlorine. If there is a difference greater than 0.2 ppm, a shock treatment should be initiated.

During peak chlorine demand (summer months, rainy season or heavy bather usage) it may be necessary to increase your chlorine output by increasing your output setting. Conversely, during low chlorine demand, you can decrease your output to a lower setting. For extremely heavy chlorine demand or to boost your chlorine residual levels quickly, you can supplement with any type of chlorine or non-chlorine shock containing potassium monopersulfate. *Note: During cold-water conditions (below 60°F) chlorine demand is reduced significantly. For colder climate regions with sustained low temperatures, contact your local pool Professional for proper pool winterizing instructions.*

10.1.2 pH

pH is a term used to refer to the degree of activity of an acid or base in the water. A low pH, acidotic or corrosive water contributes to eye and skin irritation as well as damage to pool equipment. A high pH will result in scaling, cloudy water and ineffective sanitation. Improper pH also contributes to the strong smell, red eyes and dry itchy skin conditions usually associated with “too much chlorine”.

10.1.3 Total Alkalinity

Total Alkalinity refers to the ability of the pool water to resist a change in pH. It helps manage or control the pH in the pool. The desired range is 80 to 120 ppm (mg/L). Low alkalinity is aggressive or corrosive and causes the pH readings to fluctuate (pH bounce). High alkalinity may cause cloudy water and scale forming conditions. Your Digital Nano/Nano⁺ provides 100% pure sodium chloride, which does not affect Total Alkalinity. Factors changing this measure are ancillary chemicals added to the pool and “out of balance” make-up water.

10.1.4 Calcium Hardness

Calcium Hardness is a measure of calcium content in the water. If the calcium content is too high, calcium can drop out of solution; forming scale on equipment. A low level will cause the water to become corrosive as the water tries to naturally form equilibrium. This means the water will “leach” minerals from everything it meets. Damage to equipment and unpleasant swimming conditions result. Your Digital Nano/Nano⁺ provides 100% pure sodium which does not change Calcium Hardness. Factors changing this measure are ancillary chemicals added to the pool and “out of balance” make-up water.

10.1.5 Cyanuric Acid

Cyanuric Acid acts as water “Stabilizer” or “Conditioner”. This chemical goes by either trade name and allows your chlorine residual to last longer by protecting it from the UV rays of the sun. With low Cyanuric acid, chlorine can be used up just as quickly as it is generated. Check local commercial codes for maximum acceptable Cyanuric acid levels in commercial projects. *Note: For indoor pools, it is not necessary to maintain a stabilizer level to protect the chlorine from the UV rays. However, it is recommended to maintain a minimal 15 ppm (mg/L) to protect metallic fixtures from possible corrosion.*

10.2 USING THE SATURATION INDEX

This index is used by pool professionals to ensure that your total water chemistry does not fall into a corrosive or scaling condition. Either condition can cause premature damage to the cell, any of your other equipment, as well as your cementitious finish.

The Saturation Index is composed of the following factors:

- pH as tested
- Plus the Temperature factor
- Plus the Calcium Hardness factor
- Plus the Alkalinity factor
- Minus the Total Dissolved Solids factor (in this case the bulk of the dissolved solids are salt)

This is expressed in the formula $SI = pH + TF + CF + AF - TDSF$ and uses the following charts:

TEMPERATURE		TF	CALCIUM HARDNESS		CF	TOTAL ALKALINITY		AF	SALT LEVEL		TDSF
60 F	15.6 C	0.4	150 ppm (mg/L)	1.8	075 ppm (mg/L)	1.9	0000 - 1000 ppm (mg/L)	12.1			
66 F	18.9 C	0.5	200 ppm (mg/L)	1.9	100 ppm (mg/L)	2.0	1001 - 2000 ppm (mg/L)	12.2			
76 F	24.4 C	0.6	250 ppm (mg/L)	2.0	125 ppm (mg/L)	2.1	2001 - 3000 ppm (mg/L)	12.3			
84 F	28.9 C	0.7	300 ppm (mg/L)	2.1	150 ppm (mg/L)	2.2	3001 - 4000 ppm (mg/L)	12.4			
94 F	34.4 C	0.8	400 ppm (mg/L)	2.2	200 ppm (mg/L)	2.3	4001 - 5000 ppm (mg/L)	12.5			
103 F	39.4 C	0.9	600 ppm (mg/L)	2.4	250 ppm (mg/L)	2.4	5001 - 6000 ppm (mg/L)	12.6			

Table 8

Example:

WATER TEST RESULTS	FACTORS	WATER SATURATION
pH = 7.8	pH = 7.8	SI = 0.8 Water is scale forming and needs to be balanced
Temperature is 84°F	TF = 0.7	
Calcium Hardness is 600 ppm (mg/L)	CF = 2.4	
Total Alkalinity is 200 ppm (mg/L)	AF = 2.3	
Salt is 3500 ppm (mg/L)	TDSF = 12.4	

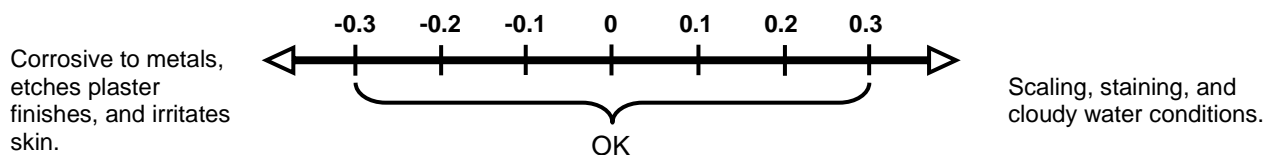

If adjustments need to be made to balance the water, the recommended sequence is as follows:

- 1) Test and adjust Total Alkalinity. This may reduce pH so wait at least 8 hours before proceeding.
- 2) Test again and adjust pH, then
- 3) Adjust Calcium Hardness.

10.3 SALT ADDITION CHART

The following salt charts are included for reference only; once programmed to the correct water volume, the controller will automatically indicate how much salt is required to achieve optimum water salinity.

The salt in the pool is constantly recycled during normal operation. Loss of salt during a swimming season should be minimal. Filter backwashing, draining due to rain water overflow, splashing, bathing suit drag out, and leaks are typical ways salt is lost. Salt does not leave the pool when water evaporates.

- 1) Determine pool/spa volume in (Gallons or Liters).
- 2) Find current salt level in the pool. Many pools will already have a significant salt residual, so always test water before adding salt (This can be obtained from the Control display or by testing water.)
- 3) Using Table 9, find the current salt level in the left column.
- 4) Determine and locate the pool/spa volume in the top column.
- 5) Locate the intersection of the row and column to find the amount of salt needed to bring the pool to the ideal level.
- 6) For volumes other than what is shown, use combinations of various columns.

Example:

For an 11,000 gallon pool with a salt level of 500 ppm (mg/L), the column value for 1000 gallons is added to the column value for 10,000 gallons, which gives a total of 230 pounds of salt needed to bring your pool salt level up to the ideal level of 3000 ppm (mg/L).

Pounds (kilograms) of salt needed to attain 3000 ppm (mg/L)

Current level of salt ppm (mg/L)	Pool/Spa Volume in Gallons (Liters)									
	1,000 (3,786)	2,000 (7,572)	5,000 (18,930)	10,000 (37,860)	15,000 (56,790)	20,000 (75,720)	25,000 (94,650)	30,000 (113,580)	35,000 (132,510)	40,000 (151,440)
0	25 (11)	50 (23)	125 (57)	250 (114)	376 (170)	501 (227)	626 (284)	751 (341)	876 (398)	1,002 (454)
250	23 (10)	46 (21)	115 (52)	230 (104)	344 (156)	459 (208)	574 (260)	689 (312)	803 (364)	918 (416)
500	21 (9)	42 (19)	104 (47)	209 (95)	313 (142)	417 (189)	522 (237)	626 (284)	730 (331)	835 (379)
750	19 (9)	38 (17)	94 (43)	188 (85)	282 (128)	376 (170)	470 (213)	563 (256)	657 (298)	751 (341)
1,000	17 (8)	33 (15)	83 (38)	167 (76)	250 (114)	334 (151)	417 (189)	501 (227)	584 (265)	668 (303)
1,250	15 (7)	29 (13)	73 (33)	146 (66)	219 (99)	292 (133)	365 (166)	438 (199)	511 (232)	584 (265)
1,500	13 (6)	25 (11)	63 (28)	125 (57)	188 (85)	250 (114)	313 (142)	376 (170)	438 (199)	501 (227)
1,750	10 (5)	21 (9)	52 (24)	104 (47)	157 (71)	209 (95)	261 (118)	313 (142)	365 (166)	417 (189)
2,000	8 (4)	17 (8)	42 (19)	83 (38)	125 (57)	167 (76)	209 (95)	250 (114)	292 (133)	334 (151)
2,250	6 (3)	13 (6)	31 (14)	63 (28)	94 (43)	125 (57)	157 (71)	188 (85)	219 (99)	250 (114)
2,500	4 (2)	8 (4)	21 (9)	42 (19)	63 (28)	83 (38)	104 (47)	125 (57)	146 (66)	167 (76)
3,000	Ideal									

Table 9

10.4 DECLARATION OF CONFORMITY

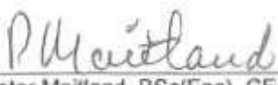
Declaration of Conformity	
(according to ISO/IEC Guide 22 and EN 45014)	
Manufacturer's Name:	Aquacal Autopilot Inc.
Manufacturer's Address:	2737 24 th Street North, St. Petersburg, Florida USA 33713.
<i>declares that the product:</i>	
Product Name:	Pool Pilot Nano
Model Number:	75041.
to which this declaration relates, meets the essential health and safety requirements and is in conformity with the relevant EU directives listed below:	
EU EMC Directive 89/392/EEC EU Low Voltage Directive 73/23/EEC	
using the relevant sections of the following EU standards and other normative documents:	
EMC:	EN55014-1:2000 + A1 + A2:2002 EN55014-2:1997 + A1:2001 EN61000-3-2:2006 EN61000-3-3:1995 + A2:2005
Safety:	EN 60335-1:2002 + A11.2004 + A1.2004 IEC 60335-1:2002 + A1.2004
Fort Lauderdale, Florida USA. March 10th 2010. (Place and date of issue)	 Peter Maitland, BSc(Eng), CEng.

10.5 FCC COMPLIANCE

NOTE: This equipment has been tested and found to comply with the limits for a Class B digital device, pursuant to part 15 of the FCC Rules. These limits are designed to provide reasonable protection against harmful interference in a residential installation. This equipment generates uses and can radiate radio frequency energy and, if not installed and used in accordance with the instructions, may cause harmful interference to radio communications. However, there is no guarantee that interference will not occur in a particular installation. If this equipment does cause harmful interference to radio or television reception, which can be determined by turning the equipment off and on, the user is encouraged to try to correct the interference by one or more of the following measures:

- Reorient or relocate the receiving antenna.
- Increase the separation between the equipment and receiver.
- Connect the equipment into an outlet on a circuit different from that to which the receiver is connected.
- Consult the dealer or an experienced radio TV technician for help.